

ChM[®]

Surgical technique

5,0 ChM Locked Plating
ChLP system

5.0ChLP calcaneal plate

Catalogue no.	
Left	Right
3.4057.000	3.4058.000

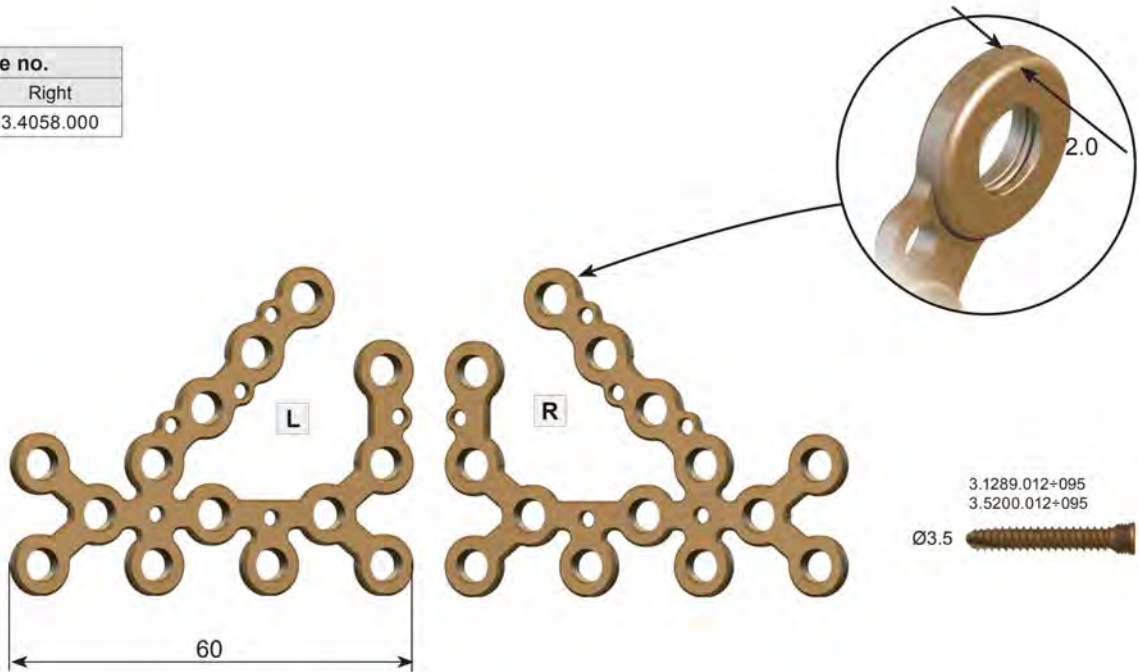

5.0ChLP calcaneal plates with hook

Catalogue no.	
Left	Right
3.4059.000	3.4060.000

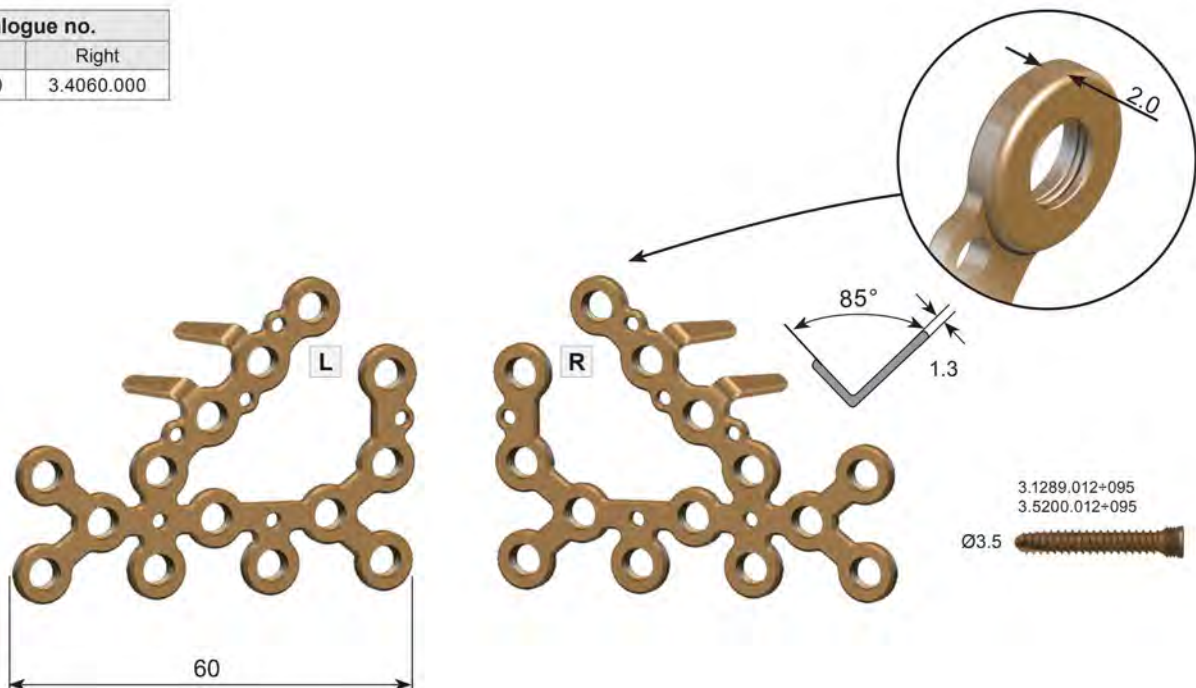

Indications

- Articular, extra-articular fractures and comminuted fractures of calcaneus.

Contraindications

Absolute:

- Health condition precluding surgery.
- Allergic reactions to the metal from which the implant is made.
- Active infection.

Relative:

- Weakened bone (*by disease, infection or prior implantation*) making it impossible to install/stabilize the implant properly.
- Abnormal perfusion of fracture area.
- Excessive obesity.
- Lack of adequate tissue coverage.
- Psychiatric disorders or the disorders of the musculoskeletal system which may create a risk of fusion failure or complications in the postoperative period.
- Other medical conditions that exclude the potential benefits of the treatment.

The patient's position



Position: laying on the side.

Surgical approach



Lateral approach.

Procedure stages

- Reduction of fracture and stabilization of the fracture fragments using Kirschner wires.
- The choice of implants - determining the length and position of the implant.
- Shaping the implant - bending arms of the plate, cutting away unnecessary holes.
- Insertion of the plate and its positioning.
- Temporary stabilization of the implant using Kirschner wires,
- Introduction of the screws (*Attention: Reduction of the bone fragments will not be possible after using locking screws. Avoid clashes of the screws!*).
- Making X-Ray film in both A-P and lateral position as to make sure the plate and screws are positioned properly.
- Closing the wound.

IV. SURGICAL TECHNIQUE

IV.1. TEMPORARY PLATE ATTACHMENT

When fracture is reduced and the plate position is confirmed, determine its temporary location using Kirschner wires 2.0 [40.4815.220].

Wires can be inserted in proximal holes of the plate and the most distal ones.



Confirm the plate position is correct taking X-ray image.

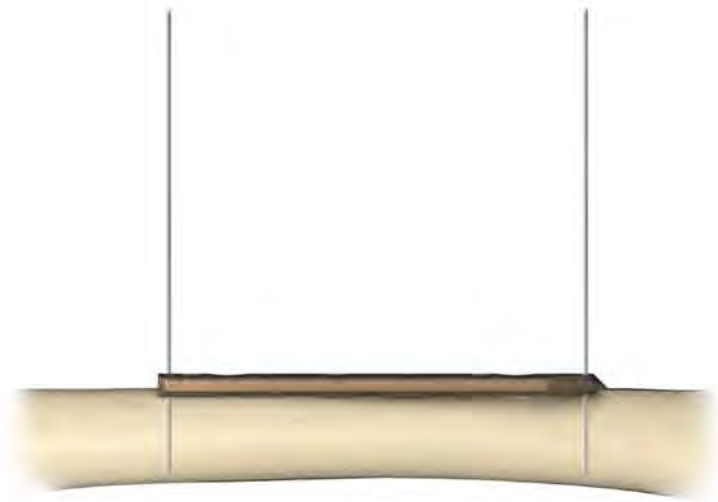

NOTE: The Setting-compressing screw 2.8/180 [40.5674.728] can be used to stabilize and tighten the plate up to the bone for temporary purposes. The screw is to be inserted via the Guide sleeve 5.0/2.8 [40.5673.728].

Locking screw $\varnothing 3.5$ can be inserted in the hole after removal of the Setting-compressing screw 2.8/180.

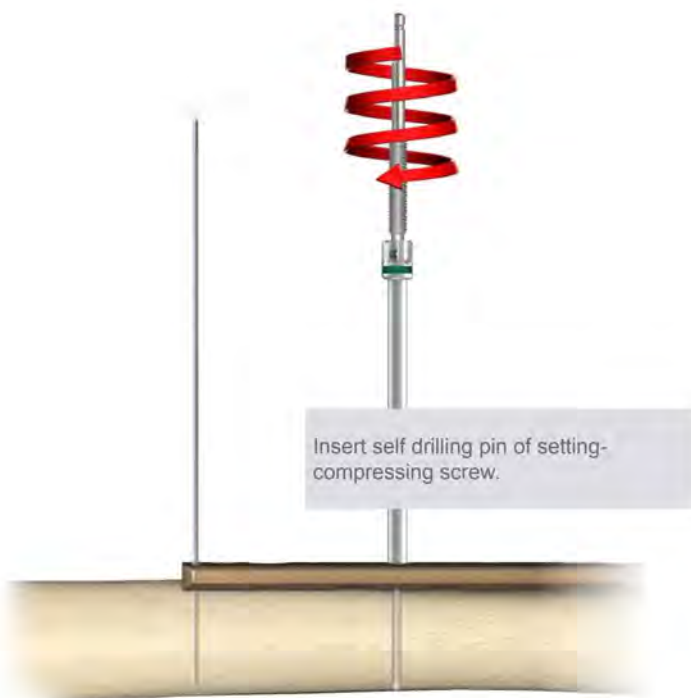

IV.2. LOCKING SCREW Ø3.5 INSERTION



It is important to drill exactly in the axis of a locking hole. Use always the appropriate guide sleeve when drilling. The guide sleeve will ensure the locking screw take an axial position towards the hole of the plate and be correctly locked in the plate. Unprepared drilling of a hole can lead to: thread skewing and jamming the screw, incorrect screw locking and problems when removing the screws (*thread seizure*).

Guide sleeve screwing.

Insert the Guide sleeve 5.0/2.8 [40.5673.728] into the plate.

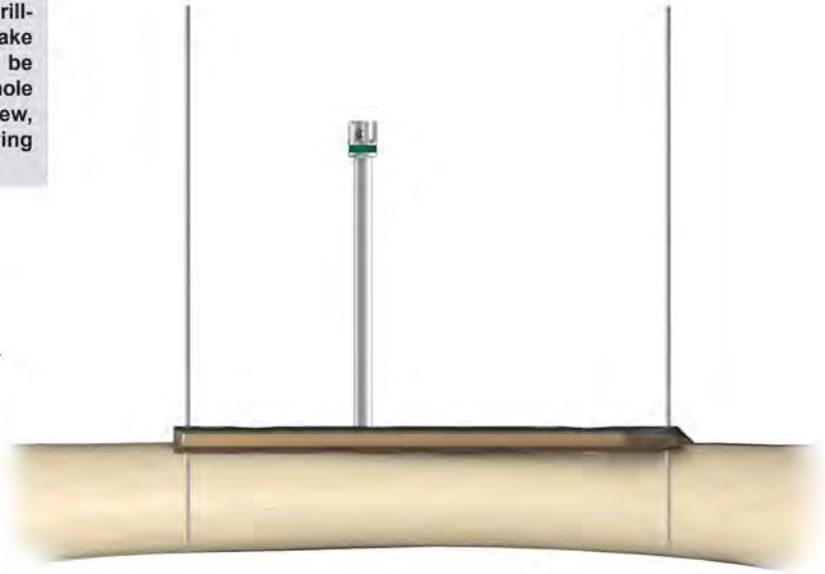

Drilling the hole

Ream the hole using the Drill with scale 2.8/220 [40.5653.222] until the desired depth is reached.

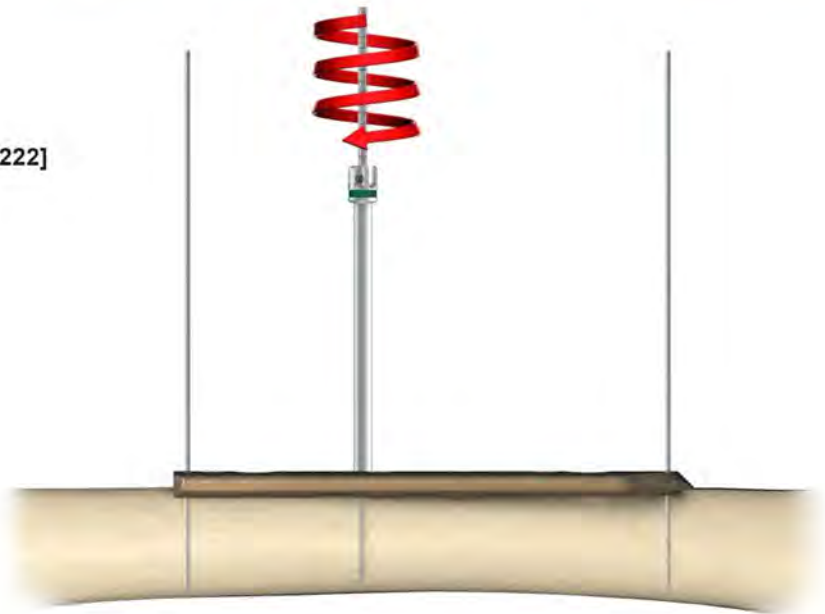

Hole depth measurement

OPTION I: Read the value on the Drill with scale [40.5653.222] or

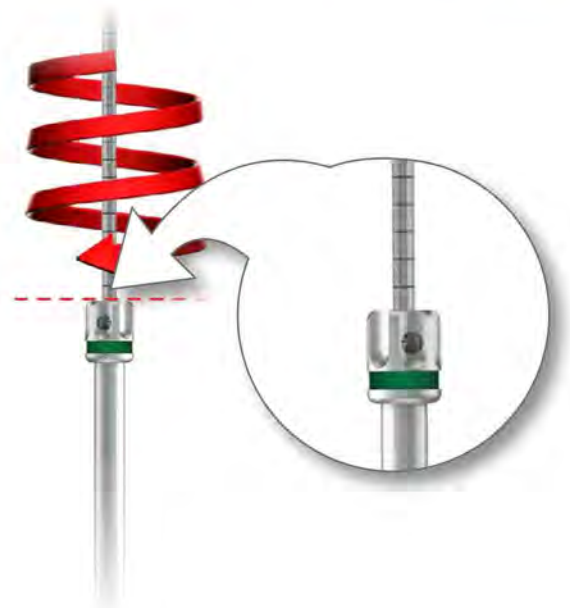

OPTION II: use the Screw length measure [40.5675.100].

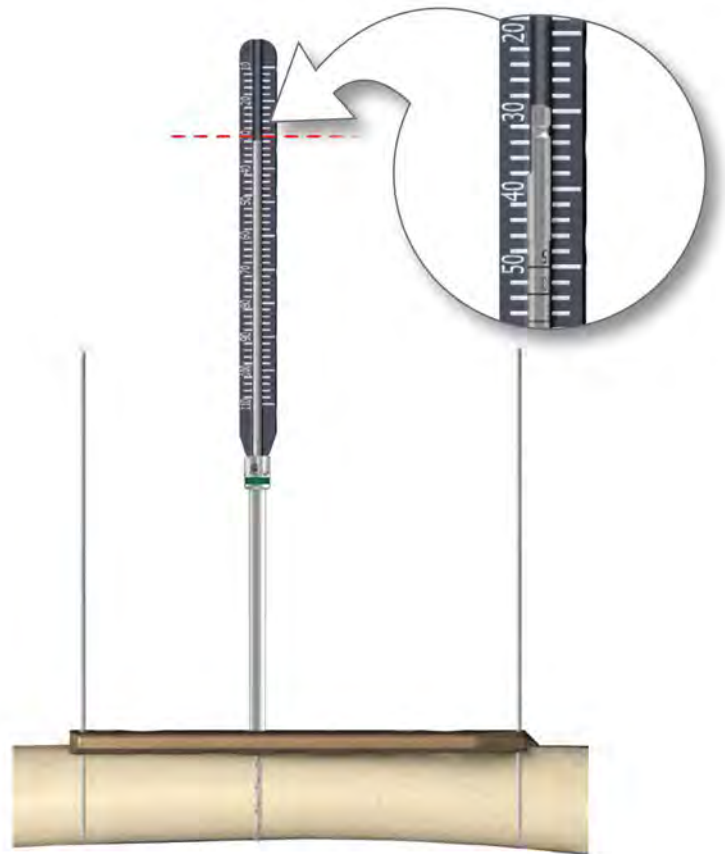

OPTION III: Unscrew the Guide sleeve 5.0/2.8 [40.5673.728] and define the screw length using the Depth measure [40.4639.500].

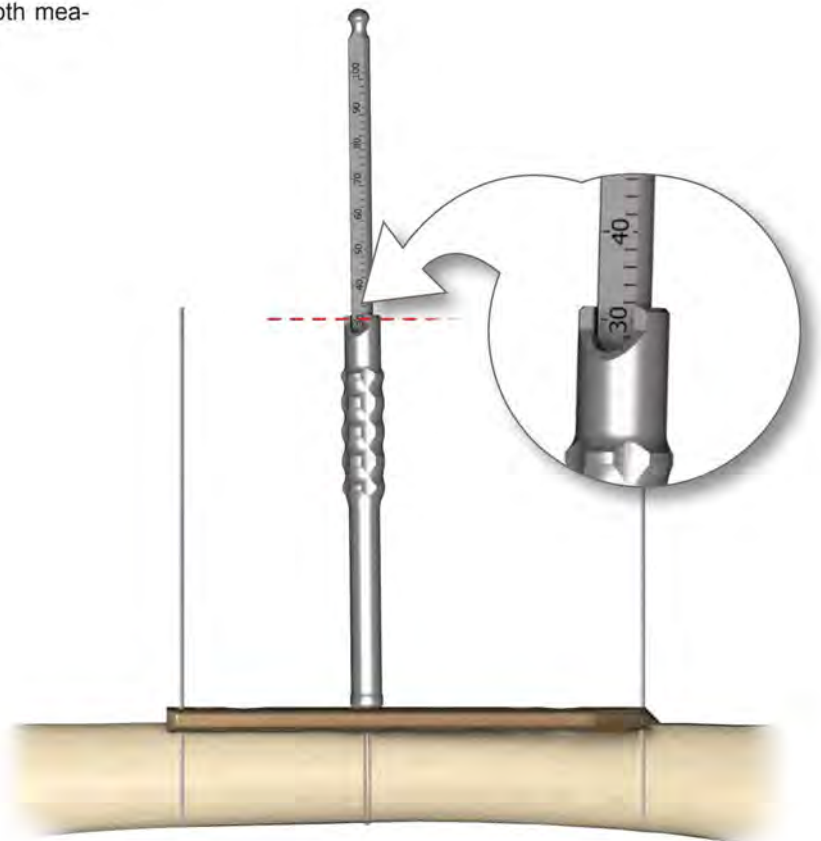

Screw insertion

Remove the Guide sleeve 5.0/2.8 [40.5673.728].

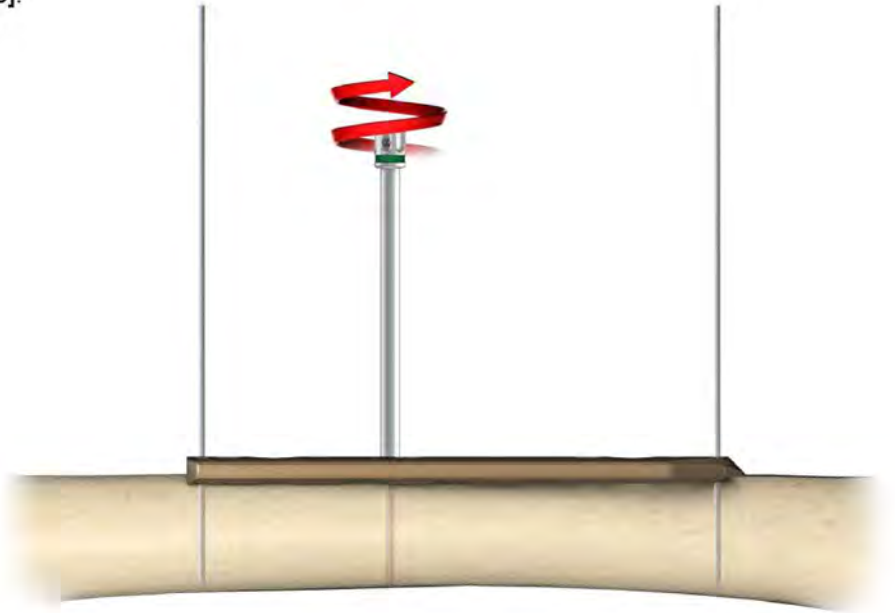

Insert the locking screw $\varnothing 3.5$ using the Torque handle 2.0Nm [40.5635] and proper screwdriver tip.

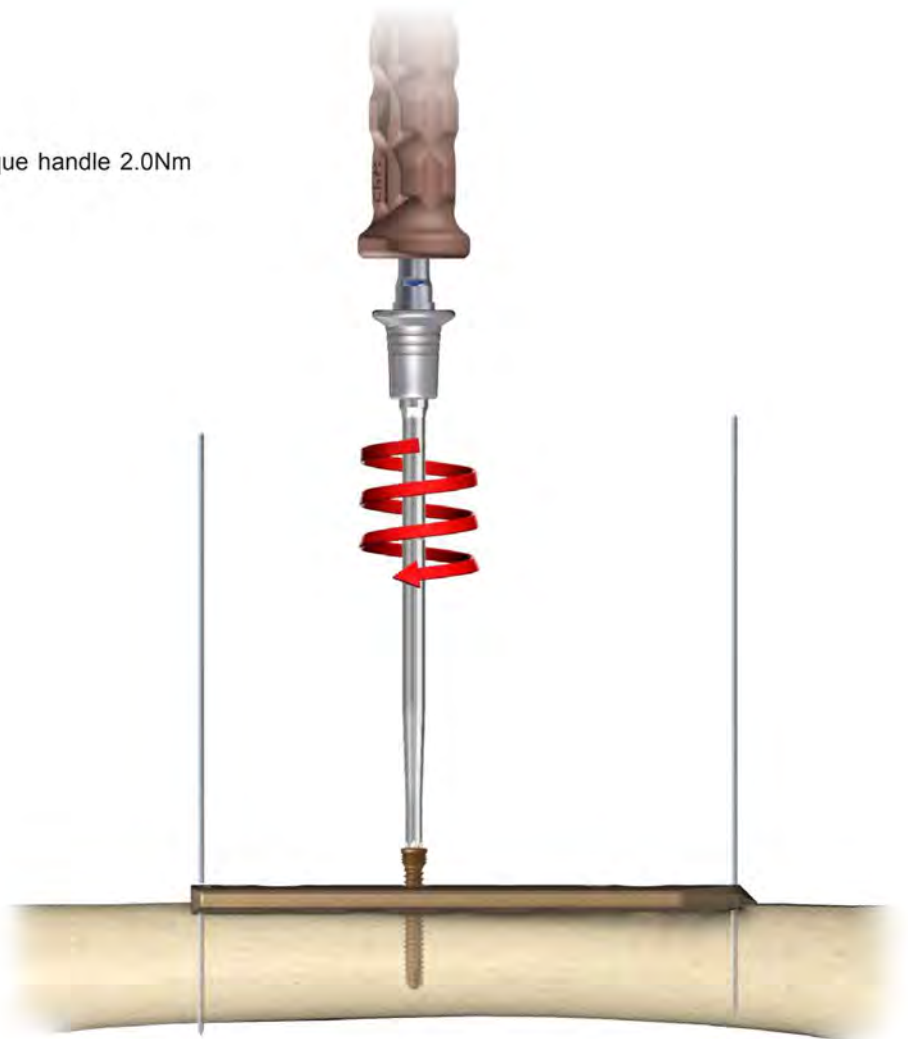

IV.4. CORTICAL SCREW Ø3.5 INSERTION

Compression guide setting

Set the Compression guide 2.5/2.8 [40.4804.700] in desire position:

a. Neutral position

Press the guide to the plate to achieve the neutral position for screw insertion.

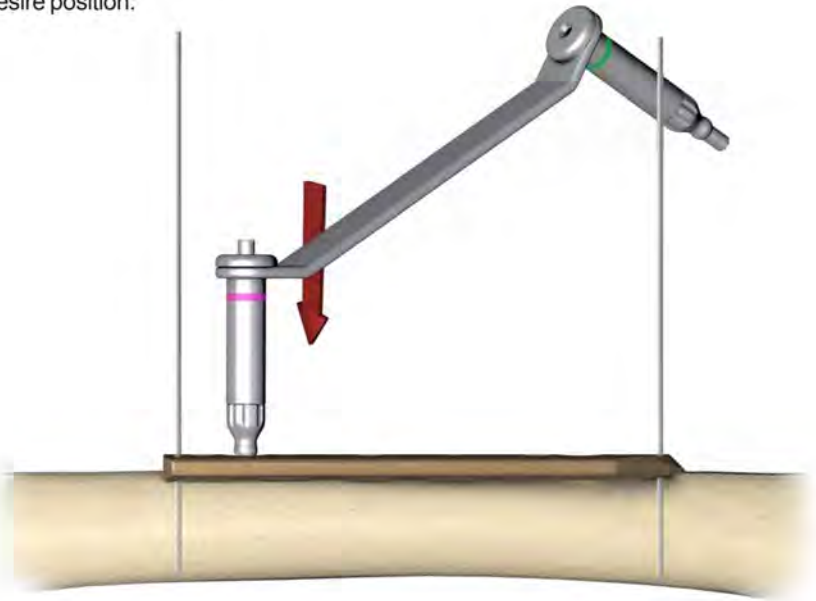

b. Compressive position

Move the guide without pressure to the edge of compression hole to achieve the compression position for screw insertion.

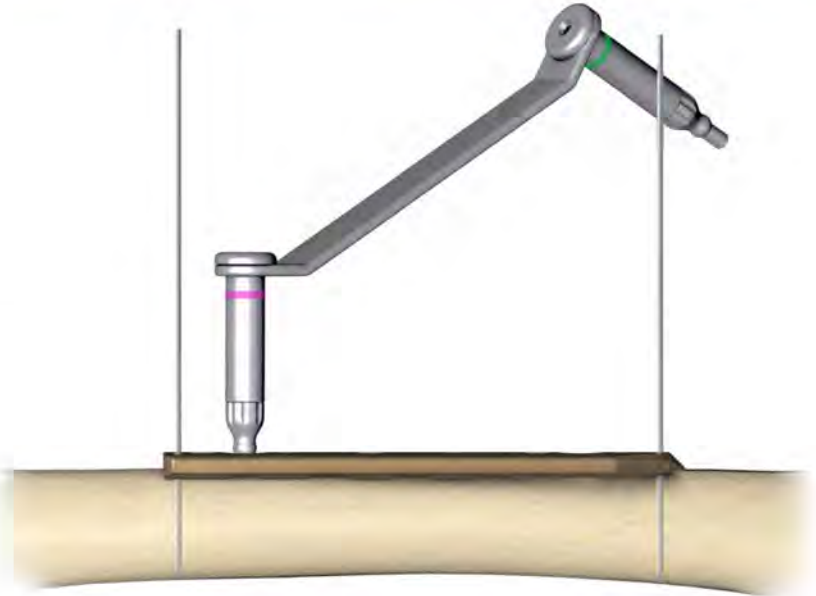

c. Angular position

Angular positioning of the guide is also available.

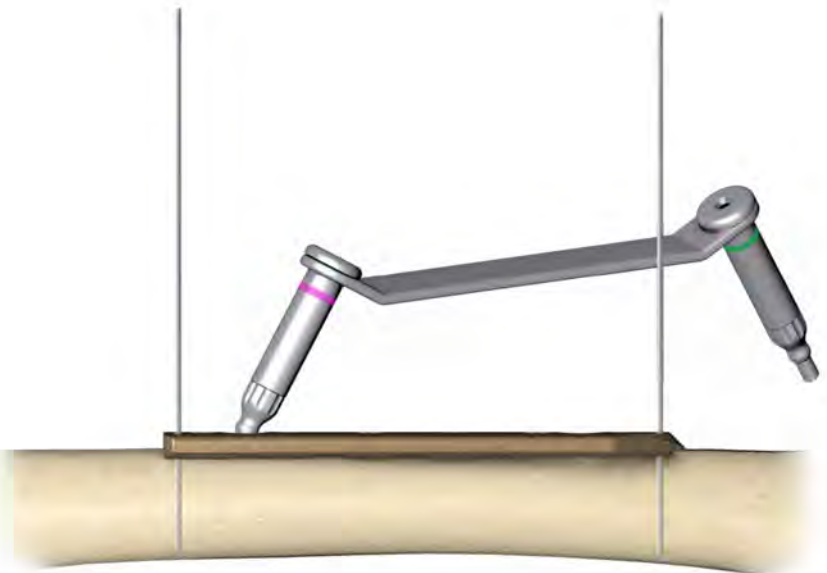

Drilling

Drill the hole through both cortices in desire position for the Cortical screw $\varnothing 3.5$ insertion using the Drill $\varnothing 2.5/220$ [40.5912.222].

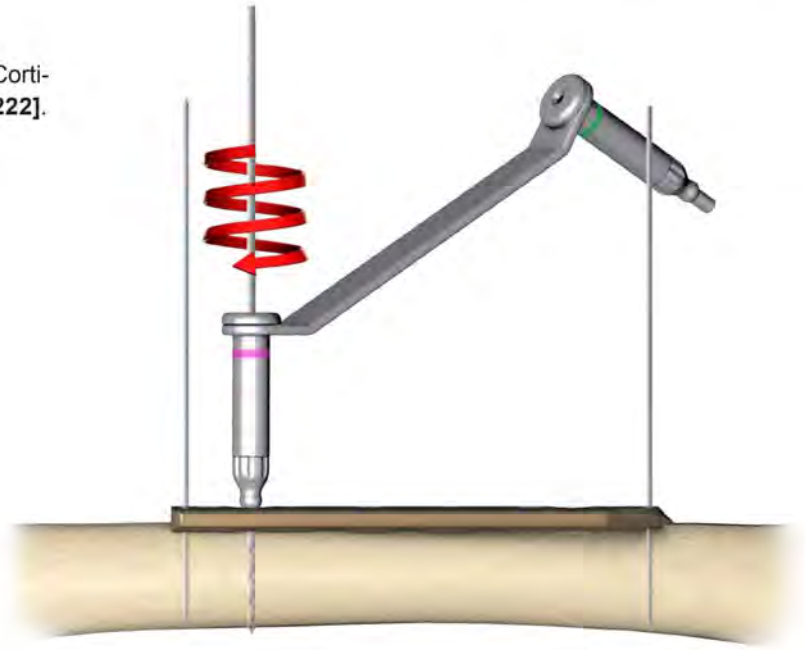

Hole depth measurement

Insert the Depth measure [40.4639.500] into the drilled hole until its hook anchors the outer surface of the opposite cortex

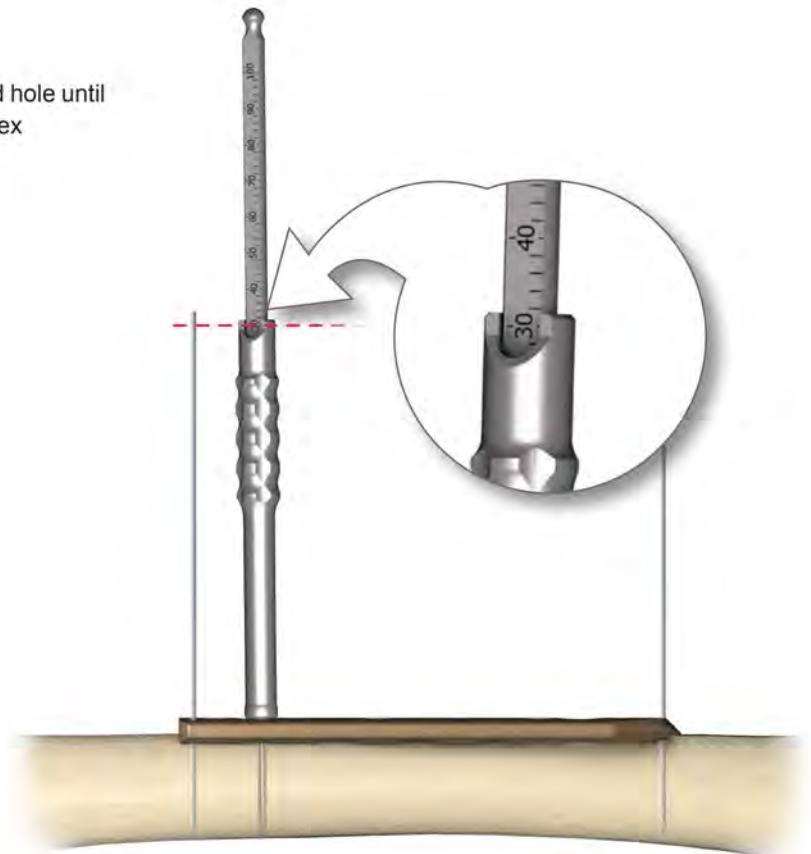

Screw insertion

Insert cortical screw Ø3.5.

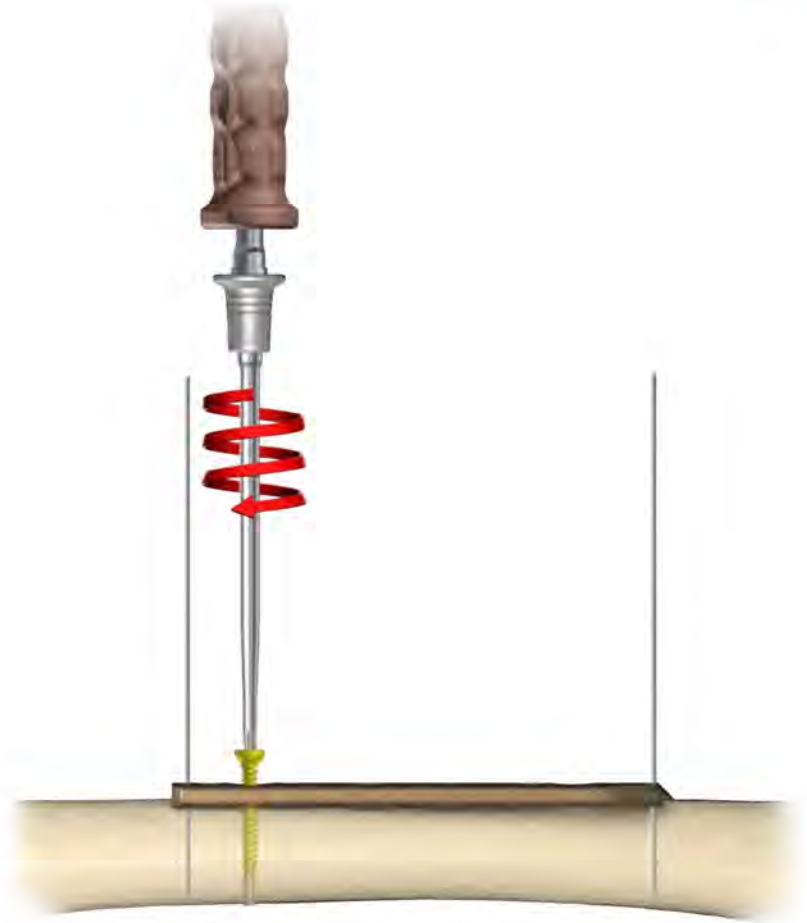

V. POSTOPERATIVE TREATMENT

Postoperative treatment after locking plates does not differ from treatment after conventional stabilization.

VI. IMPLANT REMOVAL

In order to remove the screws, first unlock all locking screws from the plate. Then remove bone screws. This prevents the rotation of the plate while removing the last locking screw.



NOTE: After removing the tissues from the outer surface of plate and screws recesses, it is recommended to apply aiming block to the plate (see point. IV.3). The use of a protective guide will ensure that: the screwdriver is positioned in the screw axis, the device is correctly placed in the screw recess and that the risk of twisting the recess while removing the screw is reduced.