

ChM<sup>®</sup>

# Surgical technique

5,0 ChM Locked Plating  
ChLP system

5.0ChLP narrow tibial plate

O	L [mm]	Catalogue no.	
		Left	Right
4	109	3.4011.504	3.4012.504
5	124	3.4011.505	3.4012.505
6	139	3.4011.506	3.4012.506
8	169	3.4011.508	3.4012.508

O – threaded holes number in shaft part of the plate

available	<b>4 - 16 holes</b> (109 mm - 289 mm)
-----------	--

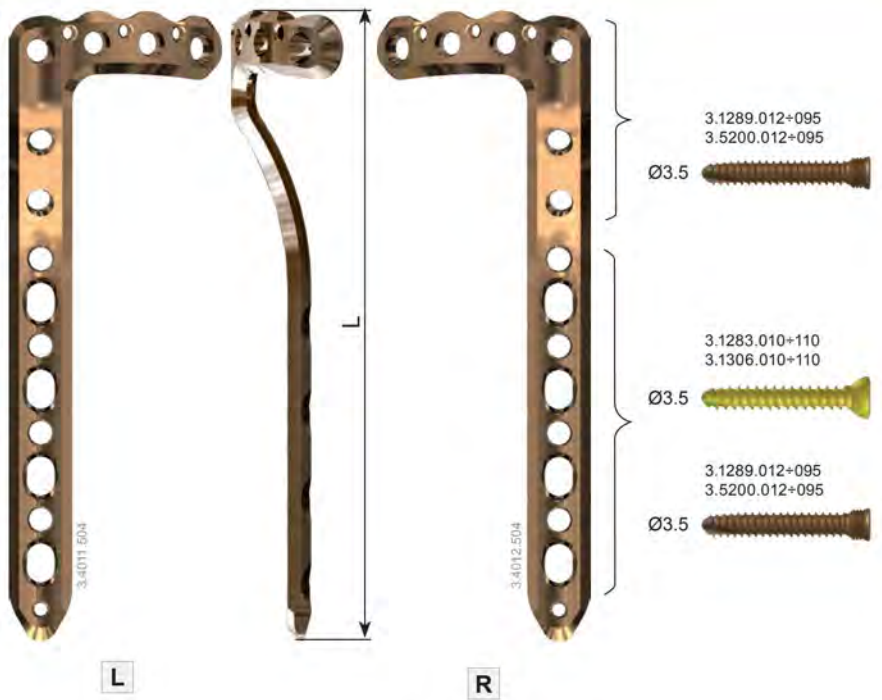

Palette for 5.0ChLP plates -3.4011/3.4012

No.	Catalogue no.	Name	Pcs	40.5758.520
1	40.5758.020	Palette	1	
2	12.0751.100	Container solid bottom 1/2 306x272x85 mm	1	
3	12.0751.200	Perforated aluminum lid 1/2 306x272x15 mm Gray	1	



implants not included

### Indications

- Articular and extra-articular, metaphyseal and epiphyseal comminuted fractures of the proximal part of the tibia and fractures extending to the shaft of the tibia.
- Non-union or malunions of fractured bone.

### Contraindications

#### Absolute:

- Health condition precluding surgery.
- Allergic reactions to the metal from which the implant is made.
- Active infection.

#### Relative:

- Weakened bone (*by disease, infection or prior implantation*) making it impossible to install/stabilize the implant properly.
- Abnormal perfusion of fracture area.
- Excessive obesity.
- Lack of adequate tissue coverage.
- Psychiatric disorders or the disorders of the musculoskeletal system which may create a risk of fusion failure or complications in the postoperative period.
- Other medical conditions that exclude the potential benefits of the treatment.

### The patient's position



### Surgical approach



**Lateral S cut - recommended for simple articular and extra-articular fractures**



**Straight anterior-lateral cut - recommended for more complex articular fractures.**

Anterior-lateral approach. The cut performed between the tibia and fibula bone and should begin approximately 1 cm proximally from the lateral condyle of the tibia to the desired length of the plate. In the minimally invasive technique, a short cut and additional cuts for the access to the holes of the shaft of the plate should be performed.

### Procedure stages

- Reduction of fracture and stabilization of the fracture fragments using Kirschner wires.
- The choice of implants - determining the length and position of the implant.
- Insertion of the plate and its positioning.
- Temporary stabilization of the implant using Kirschner wires.
- Introduction of the screws in the distal parts of the plate.
- Stabilization of the shaft using locking or compression screws.
- Positioning of the plate using the compression screw in the extended hole.
- Making X-Ray film in both A-P and lateral position as to make sure the plate and screws are positioned properly.
- Closing the wound.

## IV. SURGICAL TECHNIQUE

### IV.1. TEMPORARY PLATE ATTACHMENT

When fracture is reduced and the plate position is confirmed, determine its temporary location using Kirschner wires 2.0 [40.4815.220].

Wires can be inserted in proximal holes of the plate and the most distal ones.



Confirm the plate position is correct taking X-ray image.

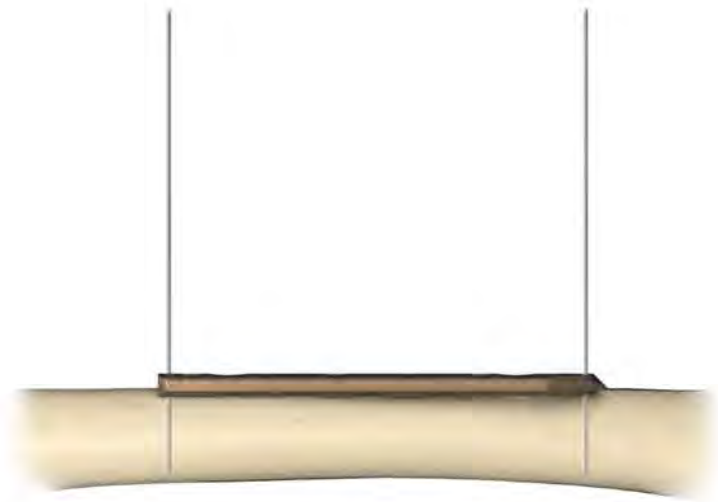

**NOTE:** The Setting-compressing screw 2.8/180 [40.5674.728] can be used to stabilize and tighten the plate up to the bone for temporary purposes. The screw is to be inserted via the Guide sleeve 5.0/2.8 [40.5673.728].

Locking screw Ø3.5 can be inserted in the hole after removal of the Setting-compressing screw 2.8/180.

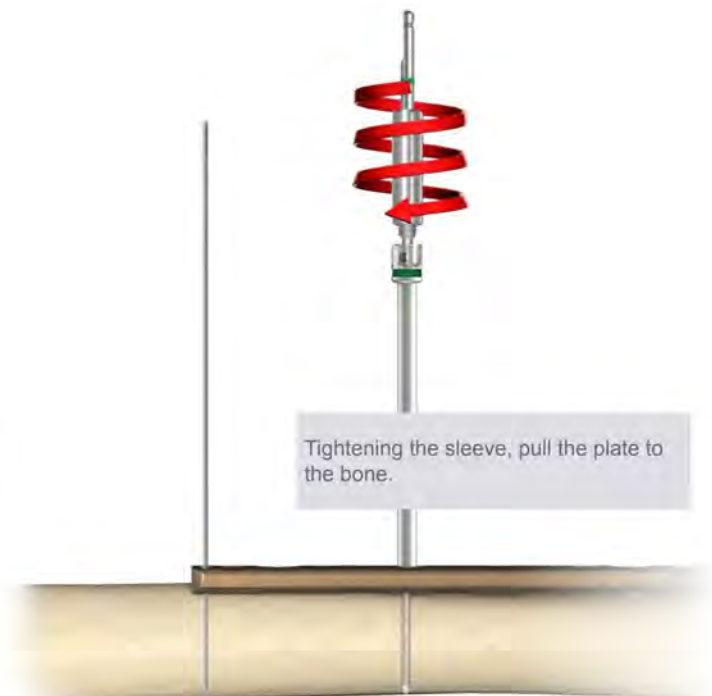

## IV.2. LOCKING SCREW Ø3.5 INSERTION



It is important to drill exactly in the axis of a locking hole. Use always the appropriate guide sleeve when drilling. The guide sleeve will ensure the locking screw take an axial position towards the hole of the plate and be correctly locked in the plate. Unprepared drilling of a hole can lead to: thread skewing and jamming the screw, incorrect screw locking and problems when removing the screws (*thread seizure*).

Guide sleeve screwing.

Insert the Guide sleeve 5.0/2.8 [40.5673.728] into the plate.

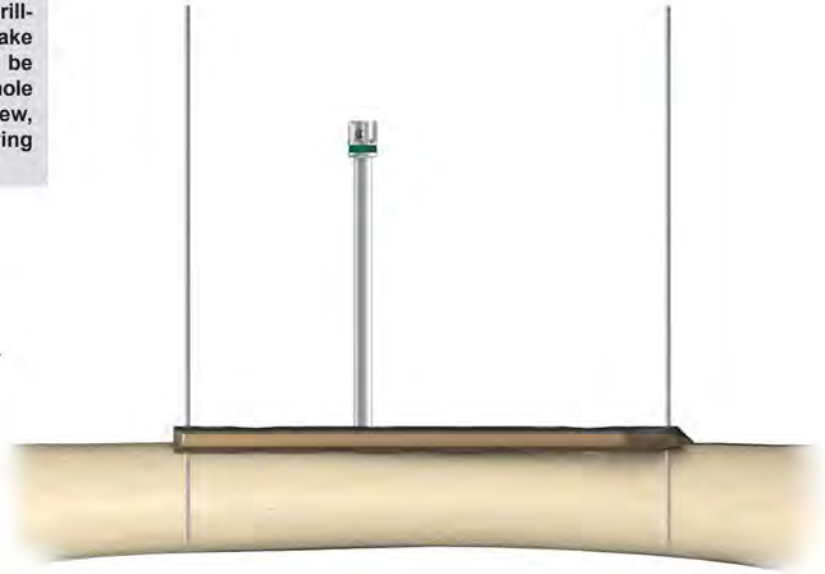

### Drilling the hole

Ream the hole using the Drill with scale 2.8/220 [40.5653.222] until the desired depth is reached.

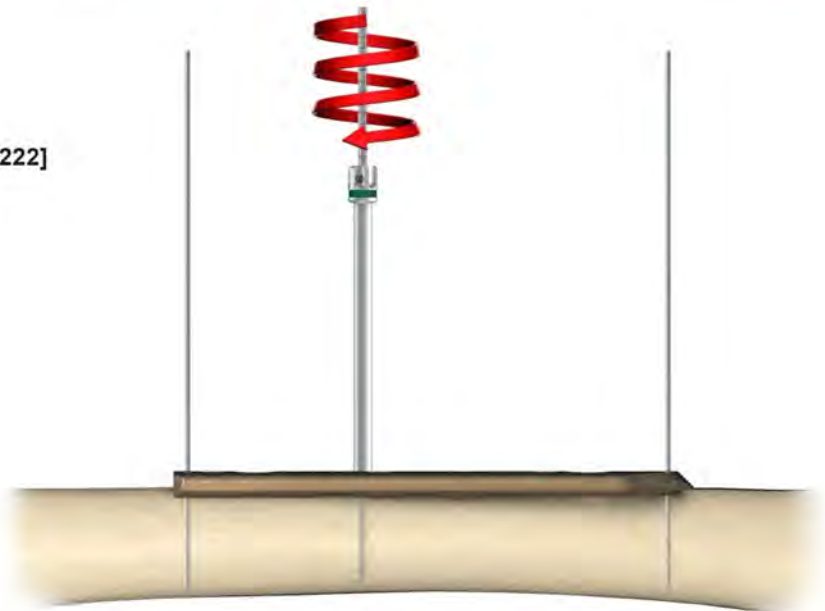

### Hole depth measurement

**OPTION I:** Read the value on the Drill with scale [40.5653.222] or

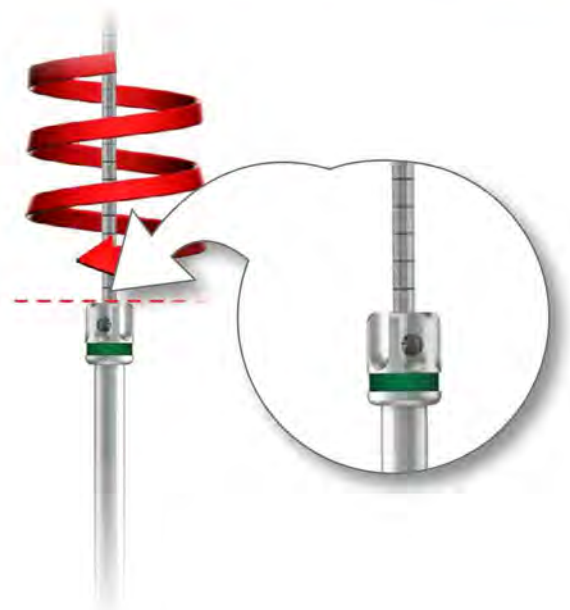

**OPTION II:** use the Screw length measure [40.5675.100].

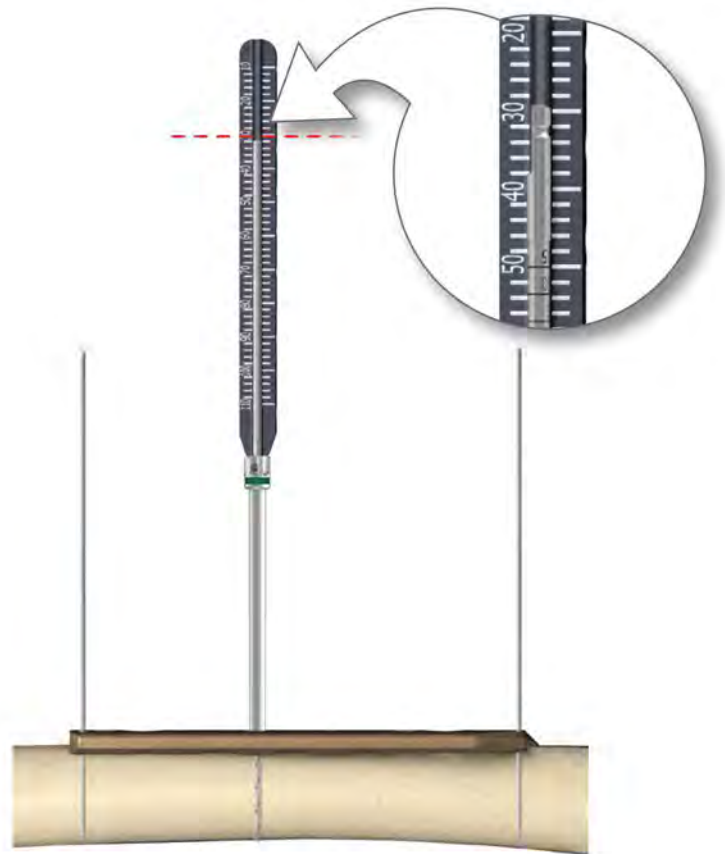

**OPTION III:** Unscrew the Guide sleeve 5.0/2.8 [40.5673.728] and define the screw length using the Depth measure [40.4639.500].

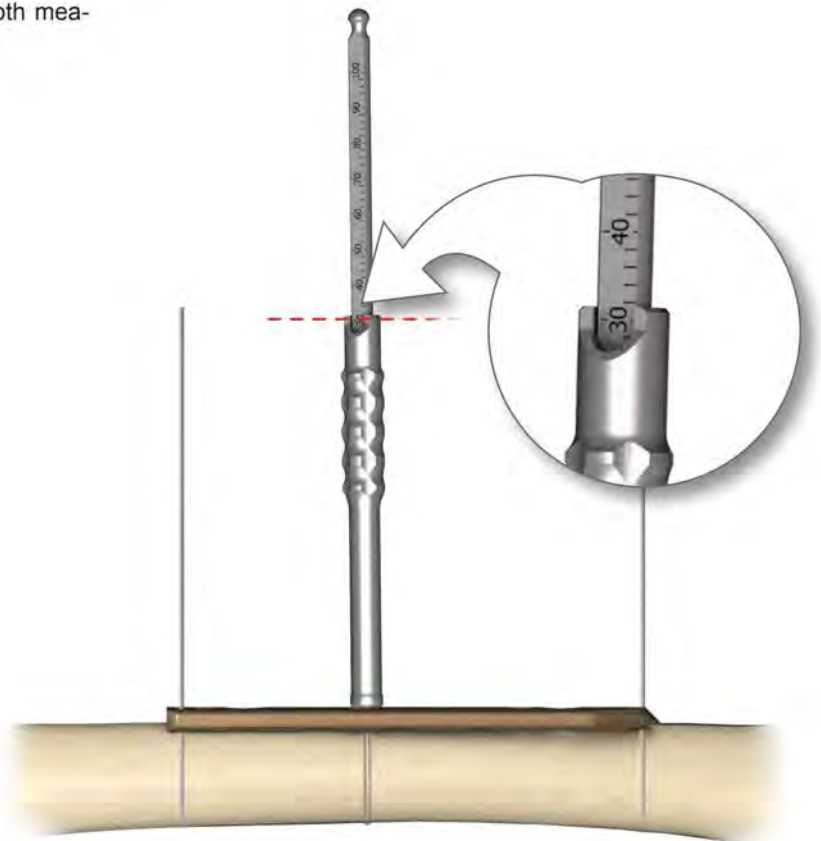

**Screw insertion**

Remove the Guide sleeve 5.0/2.8 [40.5673.728].

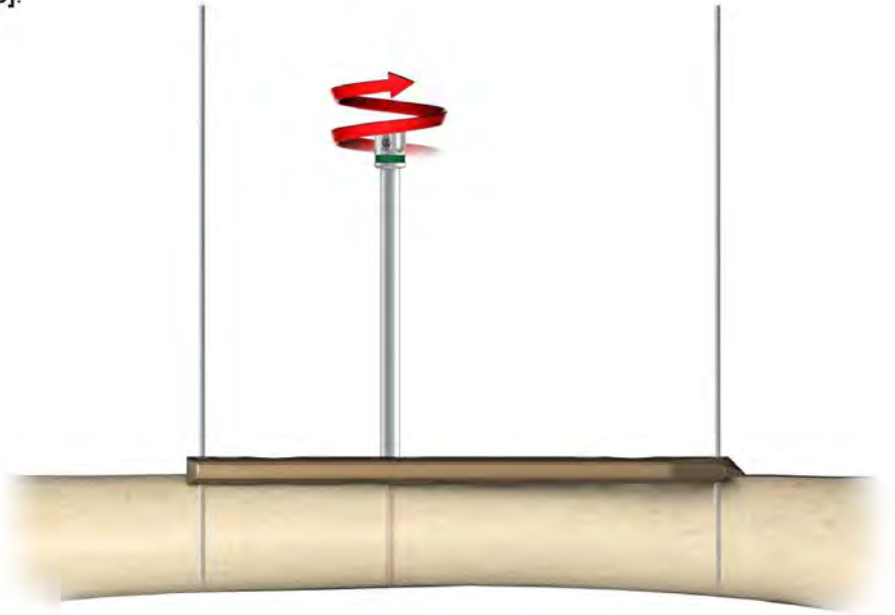

Insert the locking screw  $\text{Ø}3.5$  using the Torque handle 2.0Nm [40.5635] and proper screwdriver tip.

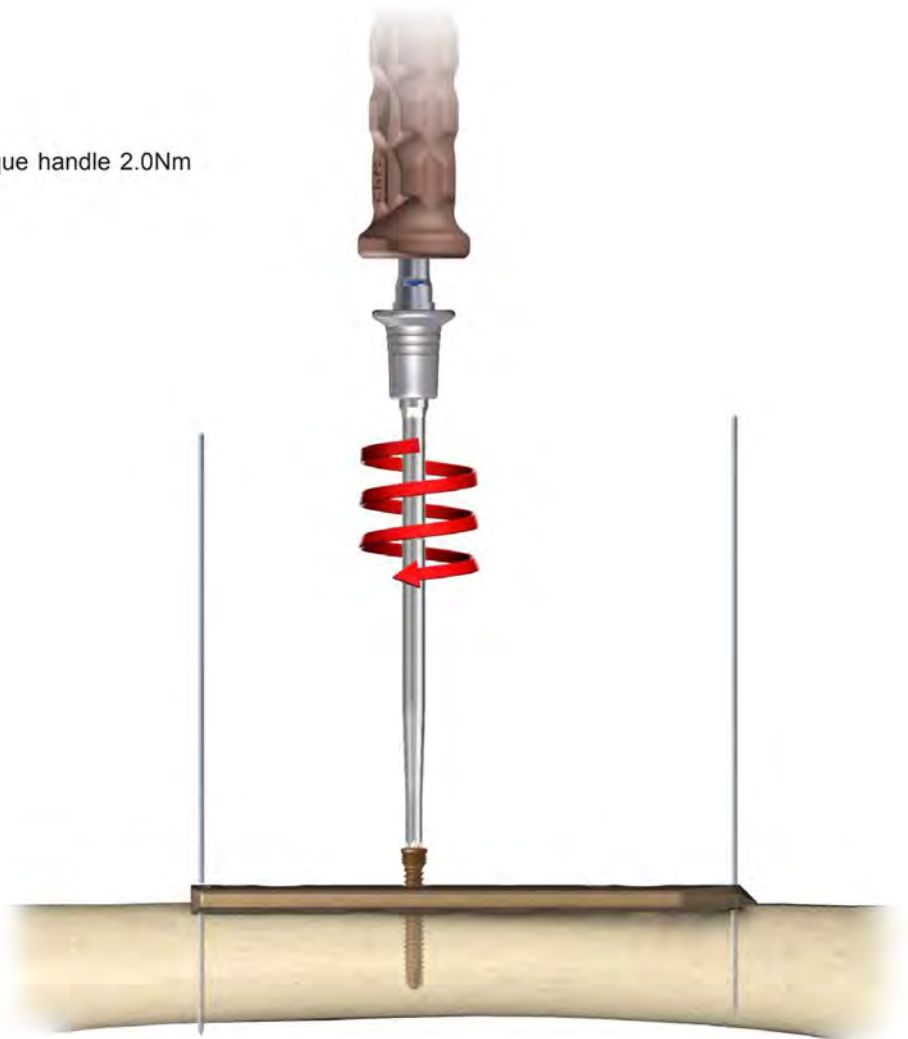

#### IV.4. CORTICAL SCREW Ø3.5 INSERTION

##### Compression guide setting

Set the Compression guide 2.5/2.8 [40.4804.700] in desire position:

##### a. Neutral position

Press the guide to the plate to achieve the neutral position for screw insertion.

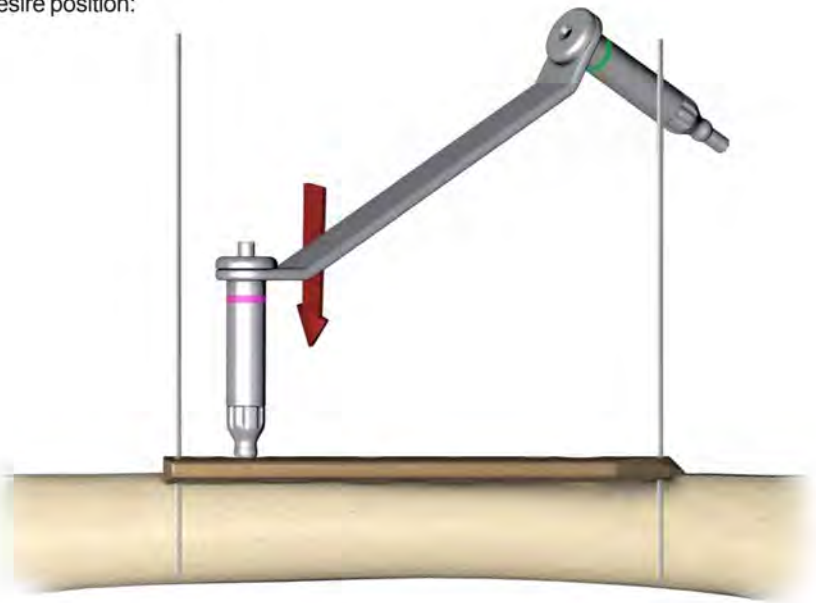

##### b. Compressive position

Move the guide without pressure to the edge of compression hole to achieve the compression position for screw insertion.

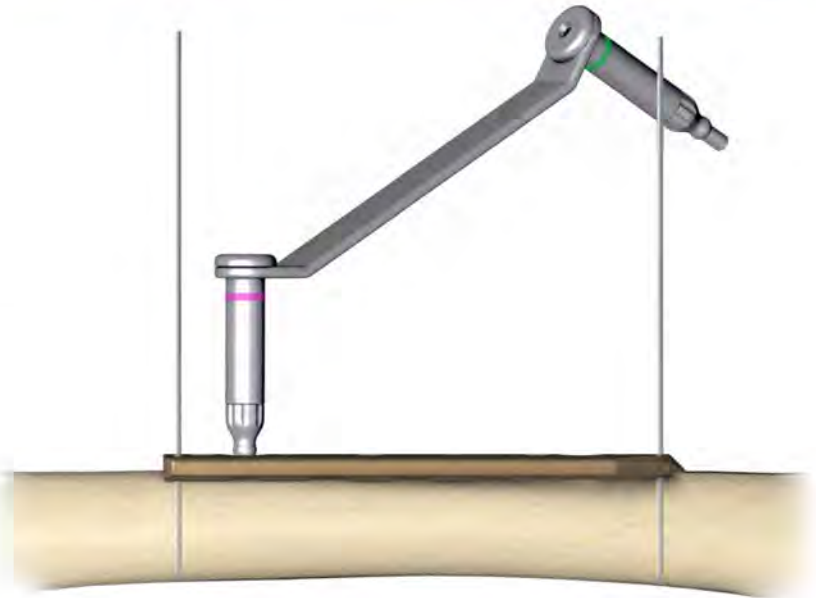

##### c. Angular position

Angular positioning of the guide is also available.

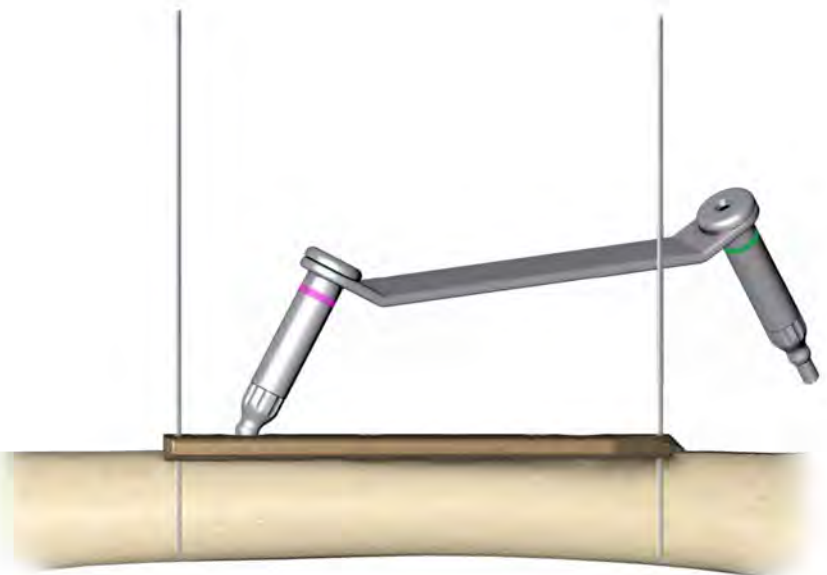



### Drilling

Drill the hole through both cortices in desire position for the Cortical screw  $\varnothing 3.5$  insertion using the Drill  $\varnothing 2.5/220$  [40.5912.222].

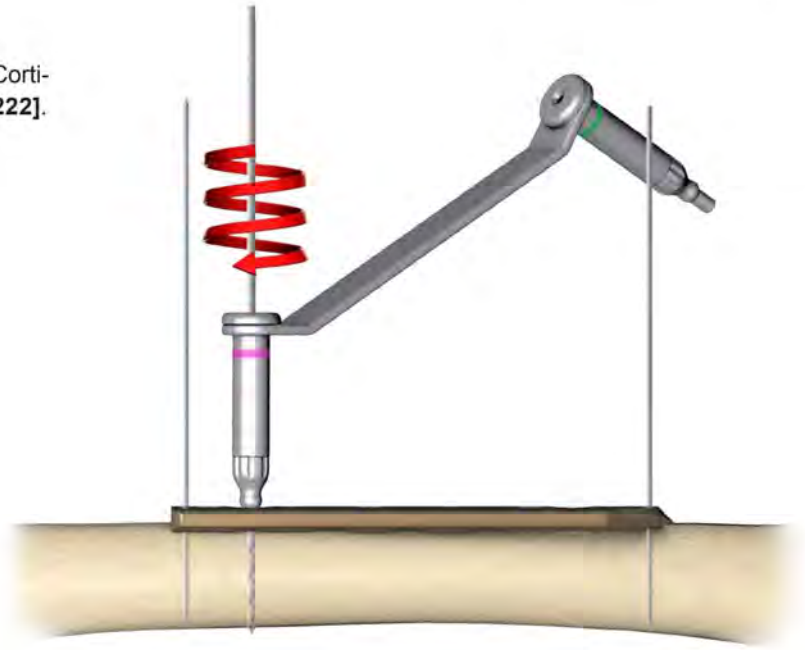

### Hole depth measurement

Insert the Depth measure [40.4639.500] into the drilled hole until its hook anchors the outer surface of the opposite cortex

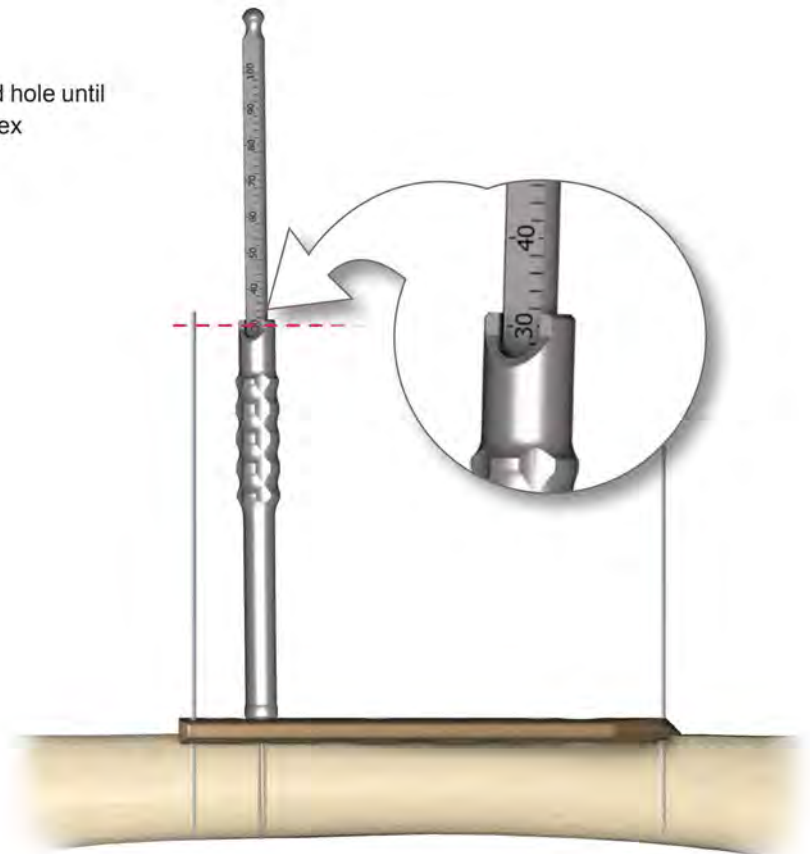

### Screw insertion

Insert cortical screw Ø3.5.

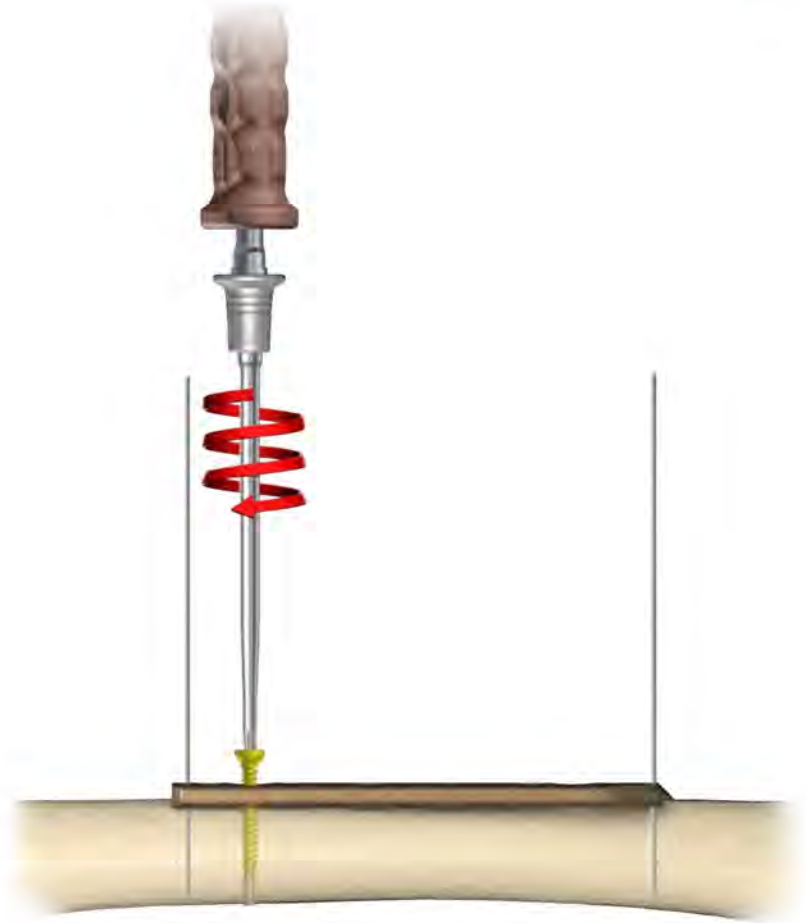

## V. POSTOPERATIVE TREATMENT

Postoperative treatment after locking plates does not differ from treatment after conventional stabilization.

## VI. IMPLANT REMOVAL

In order to remove the screws, first unlock all locking screws from the plate. Then remove bone screws. This prevents the rotation of the plate while removing the last locking screw.



**NOTE:** After removing the tissues from the outer surface of plate and screws recesses, it is recommended to apply aiming block to the plate (see point. IV.3). The use of a protective guide will ensure that: the screwdriver is positioned in the screw axis, the device is correctly placed in the screw recess and that the risk of twisting the recess while removing the screw is reduced.