

ChM[®]

ChM Micro Plates
ChMP system

MIKROSYSTEMY
MICROSYSTEMS
МИКРОХИРУРГИЯ

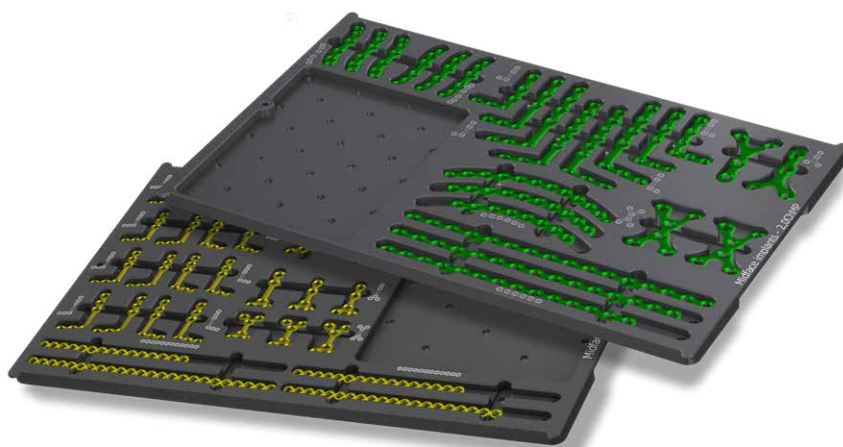

**CZĘŚĆ ŚRODKOWA TWARZY
MIDFACE
СРЕДНЯЯ ЗОНА ЛИЦА**



			Nr katalogowy/Catalogue No./ № по кат.			
grubość/ thickness толщина	0,6	L	3.3378.004	3.3382.004	3.3386.004	3.4616.004
		R	3.3380.004	3.3384.004	3.3388.004	3.4618.004
	1,0	L	3.3379.004	3.3383.004	3.3387.004	3.4617.004
		R	3.3381.004	3.3385.004	3.3389.004	3.4619.004
otwory/holes/отверстия			4	4	4	4
wymiar/size/измерение			7x15	7x17	7x18	7x20

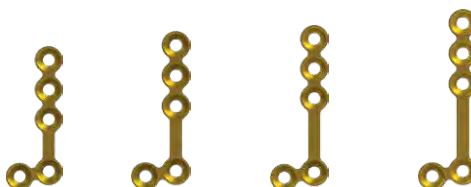

			Nr katalogowy/Catalogue No./ № по кат.			
grubość/ thickness толщина	0,6	L	3.3378.005	3.3382.005	3.3386.005	3.4616.005
		R	3.3380.005	3.3384.005	3.3388.005	3.4618.005
	1,0	L	3.3379.005	3.3383.005	3.3387.005	3.4617.005
		R	3.3381.005	3.3385.005	3.3389.005	3.4619.005
otwory/holes/отверстия			5	5	5	5
wymiar/size/измерение			7x19	7x21	7x22	7x24

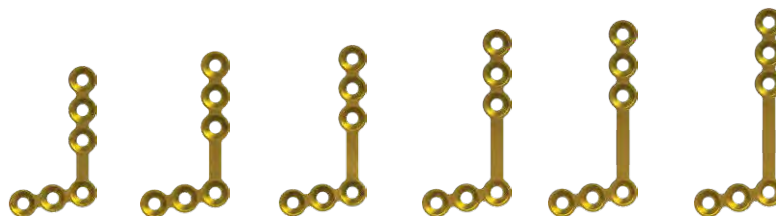

			Nr katalogowy/Catalogue No./ № по кат.					
grubość/ thickness толщина	0,6	L	3.3394.006	3.3398.006	3.4620.006	3.4624.006	3.6862.006	3.6863.006
		R	3.3396.006	3.3400.006	3.4622.006	3.4626.006	3.6866.006	3.6867.006
	1,0	L	3.3395.006	3.3399.006	3.4621.006	3.4625.006	3.6864.006	3.6865.006
		R	3.3397.006	3.3401.006	3.4623.006	3.4627.006	3.6868.006	3.6869.006
otwory/holes/отверстия			6	6	6	6	6	6
wymiar/size/измерение			12x20	12x22	12x23	12x25	12x26	12x28

CZĘŚĆ ŚRODKOWA TWARZY
MIDFACE
СРЕДНЯЯ ЗОНА ЛИЦА



		Nr katalogowy/Catalogue No./ № по кат.						
grubość/thickness толщина	0,6	3.3432.006	3.3434.006	3.4644.006	3.3414.005	3.3416.005	3.3418.005	3.4642.005
	1,0	3.3433.006	3.3435.006	3.4645.006	3.3415.005	3.3417.005	3.3419.005	3.4643.005
otwory/holes/отверстия		6	6	6	5	5	5	5
wymiar/size/измерение		9x15	9x16	9x18	9x16	9x18	9x19	9x21



		Nr katalogowy/Catalogue No./ № по кат.		
grubość/thickness толщина	0,6	3.4628.005	3.4628.006	3.4630.007
		5	6	7
otwory/holes/отверстия		5	6	7
wymiar/size/измерение		12x13	12x17	12x21



		Nr katalogowy/Catalogue No./ № по кат.		
grubość/thickness толщина	0,6	3.3348.002	3.3344.004	3.4600.006
		2	4	6
otwory/holes/отверстия		2	4	6
wymiar/size/измерение		15	20	30

**CZĘŚĆ ŚRODKOWA TWARZY
MIDFACE
СРЕДНЯЯ ЗОНА ЛИЦА**

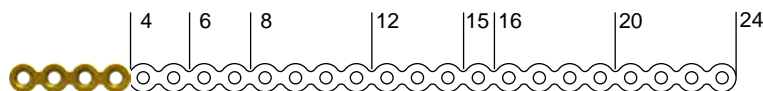

Nr katalogowy/Catalogue No./ № по кат.

grubość/thickness толщина	0,6	3.3472.004	3.3472.006	3.3472.008	3.3472.012	3.3472.015	3.3472.016	3.3472.020	3.3472.024
	1,0	3.3473.004	3.3473.006	3.3473.008	3.3473.012	3.3473.015	3.3473.016	3.3473.020	3.3473.024
otwory/holes/отверстия		4	6	8	12	15	16	20	24
wymiar/size/измерение		16	24	32	48	60	64	80	96



Nr katalogowy/Catalogue No./ № по кат.

grubość/thickness толщина	0,6	3.3474.006	3.3474.008	3.3474.010
	1,0	3.3475.006	3.3475.008	3.3475.010
otwory/holes/отверстия		6	8	10
wymiar/size/измерение		24	31	38

**Wkładka na płytki ChMP 2/2
Insert for ChMP plates 2/2
Вкладыш для пластин ChMP 2/2**

40.6446.201



Do umieszczenia w Palecie ChMP 40.6444.000
For insertion in ChMP Palette 40.6444.000
Для размещения на Поддоне ChMP 40.6444.000

CZĘŚĆ ŚRODKOWA TWARZY
MIDFACE
СРЕДНЯЯ ЗОНА ЛИЦА

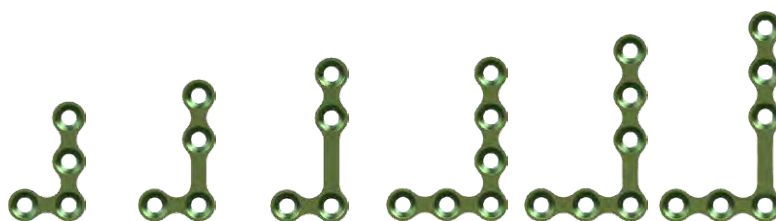

Nr katalogowy/Catalogue No./ № по кат.

grubość/thickness толщина		L	3.3700.004	3.3722.004	3.3718.004	3.3700.006	3.3722.006	3.3726.006
			0,6	R	3.3702.004	3.3724.004	3.3720.004	3.3702.006
		L	3.3701.004	3.3723.004	3.3719.004	3.3701.006	3.3723.006	3.3727.006
		R	3.3703.004	3.3725.004	3.3721.004	3.3703.006	3.3725.006	3.3729.006
otwory/holes/отверстия			4	4	4	6	6	6
wymiar/size/измерение			10x16	10x19	10x22	16x22	16x25	16x28

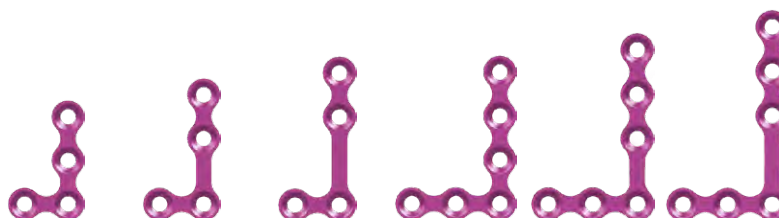

Nr katalogowy/Catalogue No./ № по кат.

grubość/ thickness	RIGID	1,0	L	3.3701.304	3.3723.304	3.3719.304	3.3701.306	3.3723.306	3.3727.306
			R	3.3703.304	3.3725.304	3.3721.304	3.3703.306	3.3725.306	3.3729.306
otwory/holes/отверстия				4	4	4	6	6	6
wymiar/size/измерение				10x16	10x19	10x22	16x22	16x25	16x28

CZĘŚĆ ŚRODKOWA TWARZY
MIDFACE
СРЕДНЯЯ ЗОНА ЛИЦА

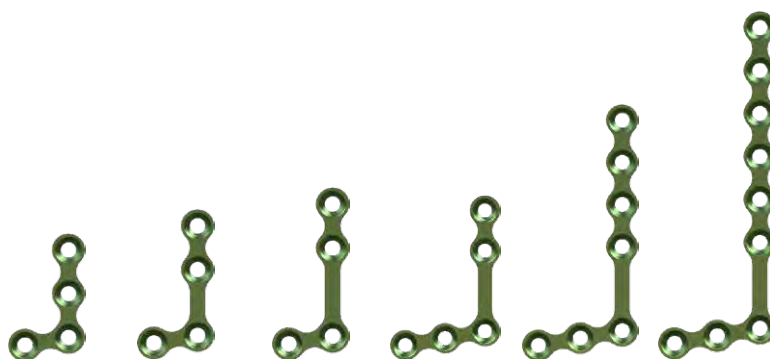

			Nr katalogowy/Catalogue No./ № по кат.						
grubość/thickness толщина	0,6	L	3.3712.004	3.4481.004	3.3714.004	3.3706.023	3.3706.035	3.3706.047	
		R	3.3713.004	3.4483.004	3.3716.004	3.3707.023	3.3707.035	3.3707.047	
	1,0	L	3.3087.017	3.4482.004	3.3715.004	3.3089.023	3.3089.035	3.3089.047	
		R	3.3088.017	3.4484.004	3.3717.004	3.3090.023	3.3090.035	3.3090.047	
otwory/holes/отверстия			4	4	4	5	7	9	
wymiar/size/измерение			10x17	10x20	10x23	16x22	16x34	16x46	

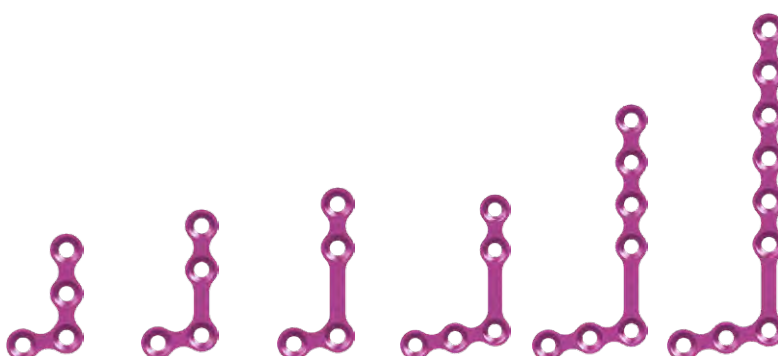

				Nr katalogowy/Catalogue No./ № по кат.						
grubość/ thickness толщина	RIGID	1,0	L	3.3087.317	3.4482.304	3.3715.304	3.3089.323	3.3089.335	3.3089.347	
			R	3.3088.317	3.4484.304	3.3717.304	3.3090.323	3.3090.335	3.3090.347	
otwory/holes/отверстия				4	4	4	5	7	9	
wymiar/size/измерение				10x17	10x20	10x23	16x22	16x34	16x46	

CZĘŚĆ ŚRODKOWA TWARZY
MIDFACE
СРЕДНЯЯ ЗОНА ЛИЦА

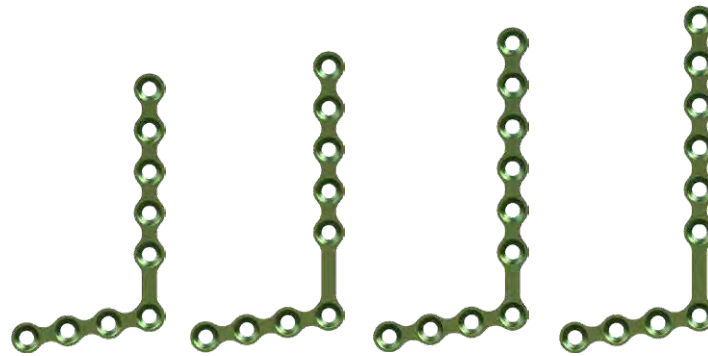

			Nr katalogowy/Catalogue No./ № по кат.			
grubość/ thickness толщина	0,6	L	3.4473.009	3.4477.009	3.4473.010	3.4477.010
		R	3.4475.009	3.4479.009	3.4475.010	3.4479.010
	1,0	L	3.4474.009	3.4478.009	3.4474.010	3.4478.010
		R	3.4476.009	3.4480.009	3.4476.010	3.4480.010
otwory/holes/отверстия			9	9	10	10
wymiar/size/измерение			22x37	22x40	22x43	22x46

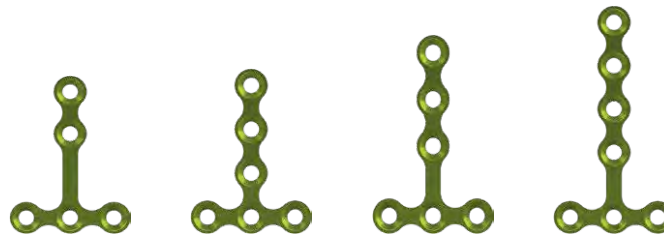

			Nr katalogowy/Catalogue No./ № по кат.			
grubość/thickness толщина		1,0	3.3749.005	3.3747.006	3.3745.006	3.3745.007
otwory/holes/отверстия			5	6	6	7
wymiar/size/измерение			16x22	16x22	16x25	16x31



			Nr katalogowy/Catalogue No./ № по кат.		
grubość/ thickness толщина	RIGID	1,0	3.3749.305	3.3747.306	3.3745.306
otwory/holes/отверстия			5	6	6
wymiar/size/измерение			16x22	16x22	16x25

CZĘŚĆ ŚRODKOWA TWARZY
MIDFACE
СРЕДНЯЯ ЗОНА ЛИЦА



Nr katalogowy/Catalogue No./ № по кат.

grubość/thickness толщина	0,6	3.3763.004	3.3761.004	3.3763.005	3.3761.005	3.3755.005	3.3757.005	3.3759.005	3.3755.006
	1,0	3.3764.004	3.3762.004	3.3764.005	3.3762.005	3.3756.005	3.3758.005	3.3760.005	3.3756.006
otwory/holes/отверстия		4	4	5	5	5	5	5	6
wymiar/size/измерение		13x19	13x22	13x25	13x28	13x22	13x25	13x28	13x28



Nr katalogowy/Catalogue No./ № по кат.

grubość/ thickness толщина	RIGID	1,0	3.3764.304	3.3762.304	3.3764.305	3.3762.305	3.3756.305	3.3758.305	3.3760.305	3.3756.306
			4	4	5	5	5	5	5	6
otwory/holes/отверстия			4	4	5	5	5	5	5	6
wymiar/size/измерение			13x19	13x22	13x25	13x28	13x22	13x25	13x28	13x28

CZĘŚĆ ŚRODKOWA TWARZY
MIDFACE
СРЕДНЯЯ ЗОНА ЛИЦА



		Nr katalogowy/Catalogue No./ № по кат.		
grubość/thickness толщина	0,6	3.3777.006	3.3779.006	3.3781.006
	1,0	3.3778.006	3.3780.006	3.3782.006
otwory/holes/отверстия		6	6	6
wymiar/size/измерение		13x22	13x25	13x28



			Nr katalogowy/Catalogue No./ № по кат.		
grubość/ thickness толщина	RIGID	1,0	3.3778.306	3.3780.306	3.3782.306
			6	6	6
otwory/holes/отверстия			6	6	6
wymiar/size/измерение			13x22	13x25	13x28

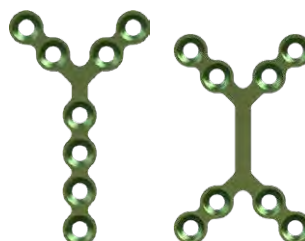

		Nr katalogowy/Catalogue No./ № по кат.	
grubość/thickness толщина	0,6	3.4456.008	3.4458.008
	1,0	3.4457.008	3.4459.008
otwory/holes/отверстия		8	8
wymiar/size/измерение		18x31	18x28

CZĘŚĆ ŚRODKOWA TWARZY
MIDFACE
СРЕДНЯЯ ЗОНА ЛИЦА



			Nr katalogowy/Catalogue No./№ по кат.	
grubość/ thickness толщина	0,6	L	3.3812.104	3.3812.106
		R	3.3812.204	3.3812.206
	1,0	L	3.3813.104	3.3813.106
		R	3.3813.204	3.3813.206
otwory/holes/отверстия			4	6
wymiar/size/измерение			8x23	8x31



Nr katalogowy/Catalogue No./ № по кат.						
grubość/thickness толщина	0,6	3.3814.004	3.3814.006	3.3814.008	3.3814.010	3.3814.012
	1,0	3.3815.004	3.3815.006	3.3815.008	3.3815.010	3.3815.012
otwory/holes/отверстия		4	6	8	10	12
wymiar/size/измерение		5x22	6x34	8x46	10x57	13x67



		Nr katalogowy/ Catalogue No./№ по кат.
grubość/thickness толщина	1,0	3.3803.015
otwory/holes/отверстия		2
wymiar/size/измерение		15



		Nr katalogowy/ Catalogue No./№ по кат.
grubość/thickness толщина	1,0	3.3085.119
otwory/holes/отверстия		4
wymiar/size/измерение		21

CZĘŚĆ ŚRODKOWA TWARZY
MIDFACE
СРЕДНЯЯ ЗОНА ЛИЦА



Nr katalogowy/Catalogue No./ № по кат.

grubość/thickness толщина	0,6	3.3804.025	3.3804.004	3.3806.004	3.3808.638	3.3808.641
		1,0	3.3805.025	3.3805.004	3.3807.004	3.3809.638
otwory/holes/отверстия		4	4	4	6	6
wymiar/size/измерение		26	28	32	38	40



Nr katalogowy/Catalogue No./ № по кат.

grubość/ thickness толщина	RIGID	1,0	3.3805.325	3.3805.304	3.3807.304	3.3809.438	3.3809.441
	otwory/holes/отверстия		4	4	4	6	6
wymiar/size/измерение		25	28	31	37	40	

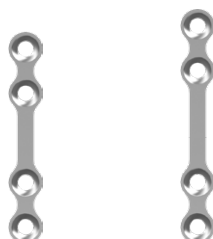

Nr katalogowy/Catalogue No./
№ по кат.

grubość/ thickness толщина	EXTRA RIGID	1,0	3.4773.011	3.4773.015
	otwory/holes/отверстия		4	4
wymiar/size/измерение		27	32	

**CZĘŚĆ ŚRODKOWA TWARZY
MIDFACE
СРЕДНЯЯ ЗОНА ЛИЦА**

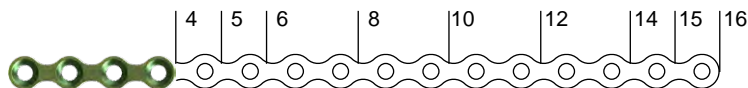

Nr katalogowy/Catalogue No./ № по кат.

grubość/thickness толщина	0,6	3.3816.504	3.3816.505	3.3816.506	3.3816.508	3.3816.510	3.3816.512	3.3816.514	3.3816.515	3.3816.516
	1,0	3.3086.504	3.3086.505	3.3086.506	3.3086.508	3.3086.510	3.3086.512	3.3086.514	3.3086.515	3.3086.516
	1,5	3.4772.504	3.4772.505	3.4772.506	3.4772.508	3.4772.510	3.4772.512	3.4772.514	3.4772.515	3.4772.516
otwory/holes/отверстия		4	5	6	8	10	12	14	15	16
wymiar/size/измерение		23	28	35	47	58	70	82	88	95



Nr katalogowy/Catalogue No./ № по кат.

grubość/ thickness толщина	RIGID	1,0	3.3086.404	3.3086.406	3.3086.408	3.3086.416	3.3086.420
		1,5	-	-	-	3.4772.416	-
otwory/holes/отверстия			4	6	8	16	20
wymiar/size/измерение			23	35	47	95	119

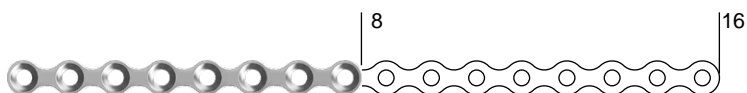

Nr katalogowy/Catalogue No./ № по кат.

grubość/ thickness толщина	EXTRA RIGID	1,0	3.4774.008	3.4774.016
			8	16
wymiar/size/измерение			47	95

Wkładka na płytki ChMP 2/2

Insert for ChMP plates 2/2

Вкладыш для пластин ChMP 2/2

40.6446.303



Do umieszczenia w Paletcie ChMP 40.6444.000
For insertion in ChMP Palette 40.6444.000
Для размещения на Поддоне ChMP 40.6444.000

**WYROSTEK KŁYKCIOWY ŻUCHWY
MANDIBULAR CONDYLE
МЫШЕЛКОВЫЙ ОТРОСТОК НИЖНЕЙ ЧЕЛЮСТИ**



		Nr katalogowy/Catalogue No./№ по кат.
grubość/thickness толщина	1,0	3.6880.000
otwory/holes/отверстия		9
wymiar/size/измерение		14x22

WYROSTEK KŁYKCIOWY ŻUCHWY
MANDIBULAR CONDYLE
МЫШЦЕЛКОВЫЙ ОТРОСТОК НИЖНЕЙ ЧЕЛЮСТИ

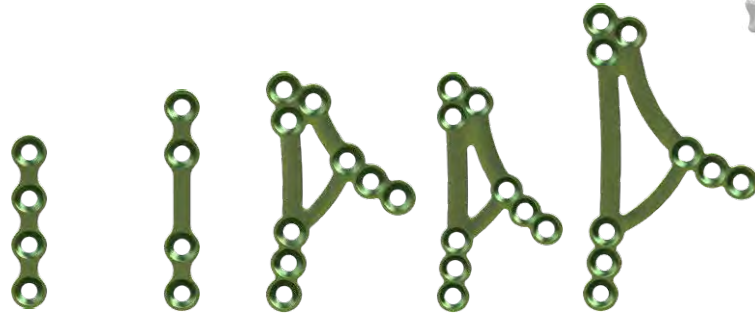

		Nr katalogowy/Catalogue No./ № по кат.					
grubość/ thickness толщина	1,0	L R	3.3086.504	3.3805.004	3.4717.001	3.4717.002	3.4717.003
					3.4718.001	3.4718.002	3.4718.003
otwory/holes/отверстия			4	4	9	9	9
wymiar/size/измерение			23	29	19x31	16x31	23x40
					Wykonane we współpracy z: Made in cooperation with: Выполнено в сотрудничестве с:		
					UNIWERSYTET MEDYCZNY W ŁODZI		

Wkładka na płytki ChMP 1/2
Insert for ChMP plates 1/2
Вкладыш для пластин ChMP 1/2

40.6446.301



Do umieszczenia w Palecie ChMP 40.6444.000
For insertion in ChMP Palette 40.6444.000
Для размещения на Поддоне ChMP 40.6444.000

WYROSTEK KŁYKCIOWY ŻUCHWY
MANDIBULAR CONDYLE
МЫЩЕЛКОВЫЙ ОТРОСТОК НИЖНЕЙ ЧЕЛЮСТИ

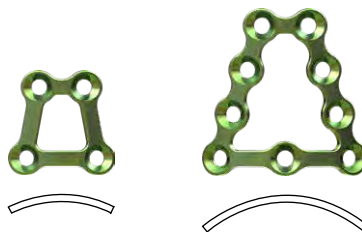

Nr katalogowy/Catalogue No./№ по кат.

grubość/thickness толщина	1,0	3.6800.004	3.6801.009
otwory/holes/отверстия		4	9
wymiar/size/измерение		14x14	22x22



Nr katalogowy/Catalogue No./№ по кат.

grubość/thickness толщина	1,0	3.6810.004	3.6811.004
otwory/holes/отверстия		4	4
wymiar/size/измерение		14x13	12x20

Wkładka na płytki ChMP 1/2
Insert for ChMP plates 1/2
Вкладыш для пластин ChMP 1/2

40.6446.305



Do umieszczenia w Palecie ChMP 40.6444.000
For insertion in ChMP Palette 40.6444.000
Для размещения на Поддоне ChMP 40.6444.000

CZASZKA
CRANIUM
ЧЕРЕП

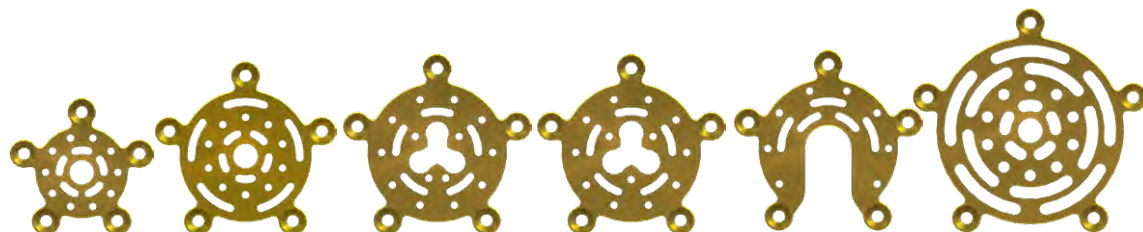

		Nr katalogowy/Catalogue No./ № по кат.					
grubość/thickness толщина	0,6	3.3476.001	3.3476.002	3.3476.003	3.3476.004	3.3476.005	-
	1,0	3.3477.001	3.3477.002	3.3477.003	3.3477.004	3.3477.005	3.3490.001
otwory/holes/отверстия		5	5	5	5	5	5
wymiar/size/измерение		19	24	25	25	25	31



		Nr katalogowy/Catalogue No./ № по кат.			
grubość/thickness толщина	0,4	3.4799.006	3.4791.006	3.4791.005	3.4792.006
		6		5	6
otwory/holes/отверстия		18	22	22	24
wymiar/size/измерение					

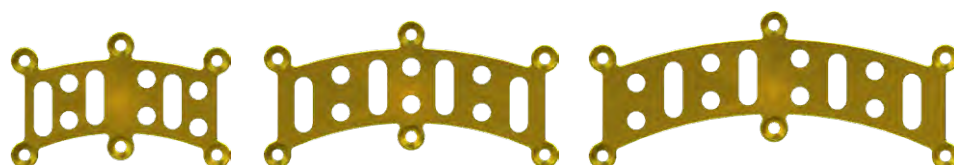

		Nr katalogowy/Catalogue No./ № по кат.		
grubość/thickness толщина	1,0	3.3487.012	3.3487.016	3.3487.018
		6	6	6
otwory/holes/отверстия		18x29	19x39	21x49
wymiar/size/измерение				

CZASZKA
CRANIUM
ЧЕРЕП

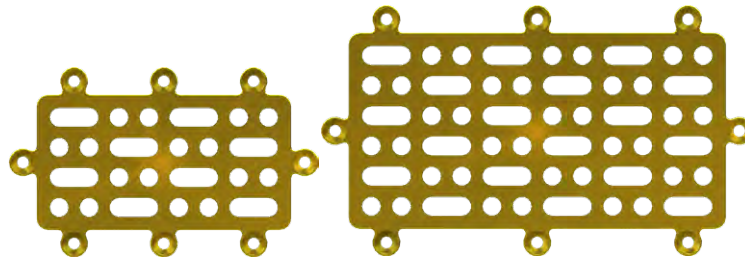

		Nr katalogowy/Catalogue No./ № по кат.	
grubość/thickness толщина	1,0	3.3489.024	3.3489.044
otwory/holes/отверстия		8	8
wymiar/size/измерение		25x41	33x57

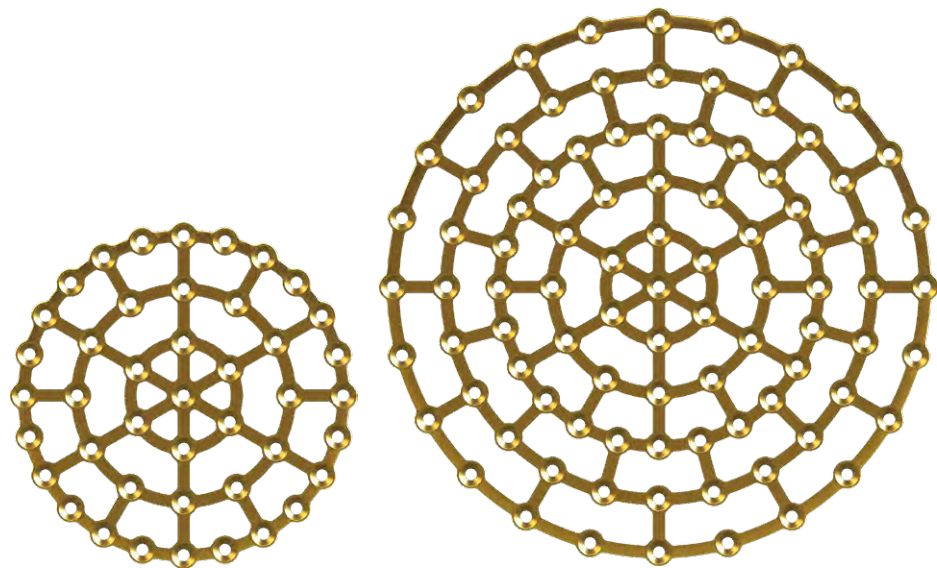

		Nr katalogowy/Catalogue No./ № по кат.	
grubość/thickness толщина	0,6	3.4710.001	3.4710.002
	1,0	3.4711.001	3.4711.002
wymiar/size/измерение		46	74

CZASZKA
CRANIUM
ЧЕРЕП

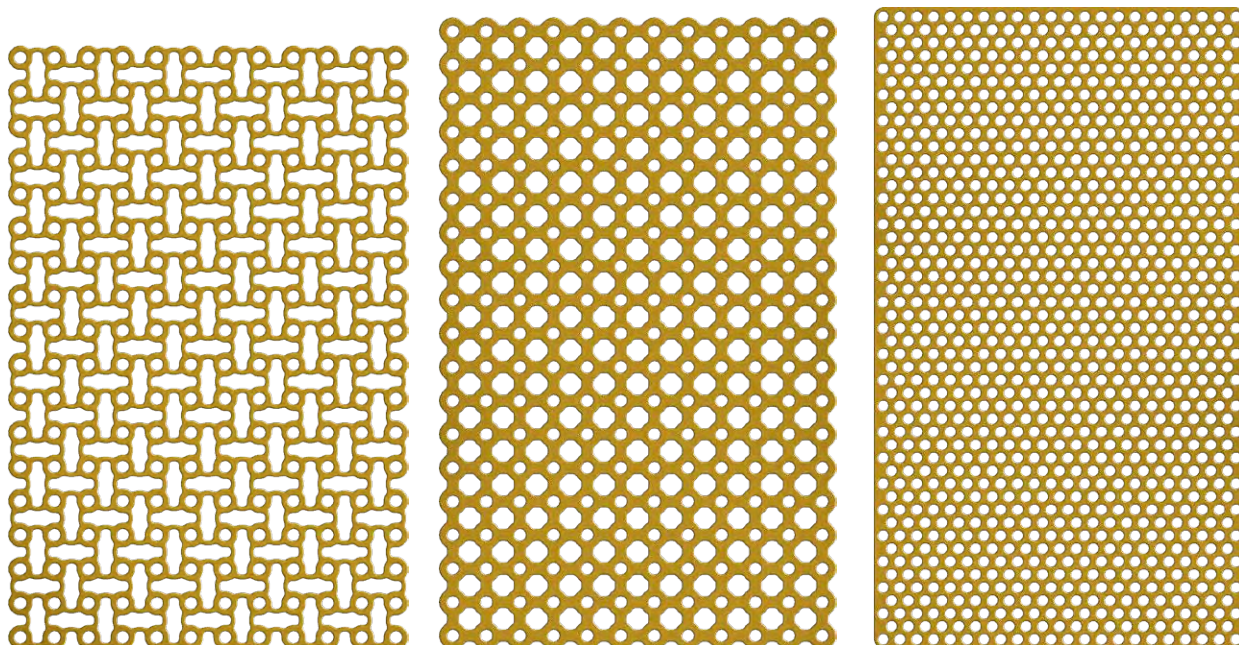

		Nr katalogowy/Catalogue No./ № по кат.		
grubość/ thickness толщина	0,2	-	-	3.3485.002
	0,3	3.3484.003	3.3483.003	-
	0,4	-	-	3.6861.000
	0,6	3.3484.006	3.3482.006	-
wymiar/size/ измерение		53x80	53x85	50x85

		Nr katalogowy/ Catalogue No./№ по кат.	
grubość/ thickness толщина	MALLEABLE	0,6	3.3484.306
wymiar/size/измерение		53x80	

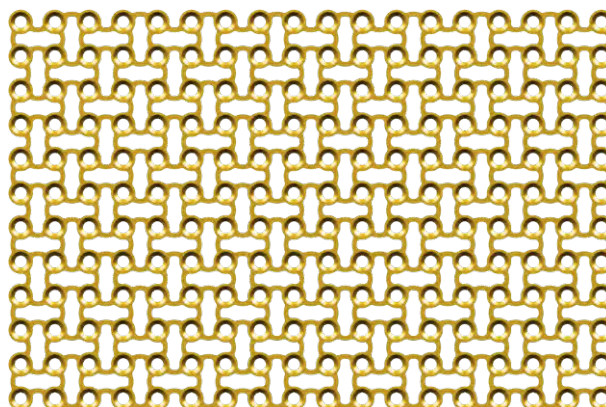

CZASZKA
 CRANIUM
 ЧЕРЕП

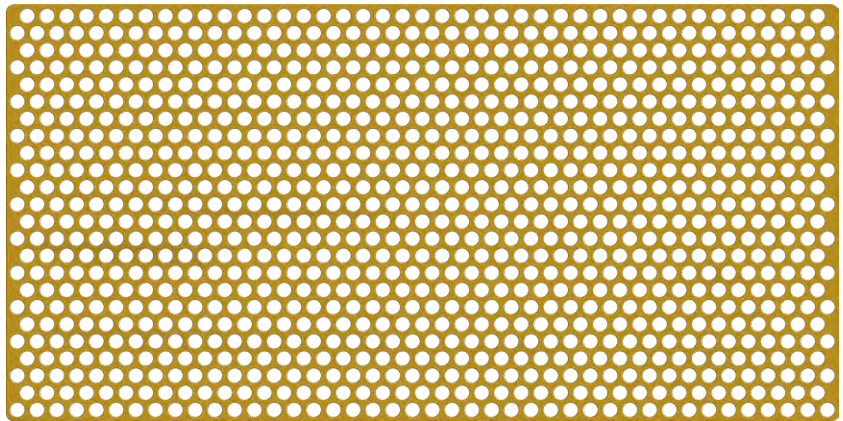
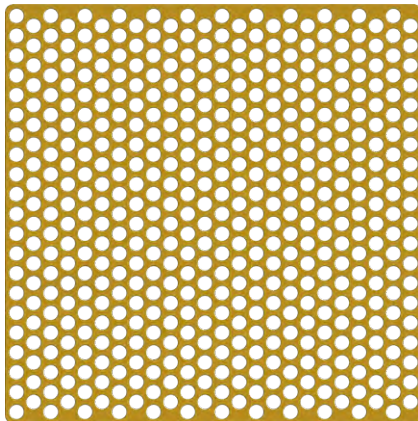

ГЛОВА / HEAD / ГОЛОВА

Nr katalogowy/Catalogue No./ № по кат.

grubość thickness толщина	0,1	3.7350.000	3.7351.000
	0,2	3.7353.000	3.7354.000
wymiar/size/измерение		55x55	55x110

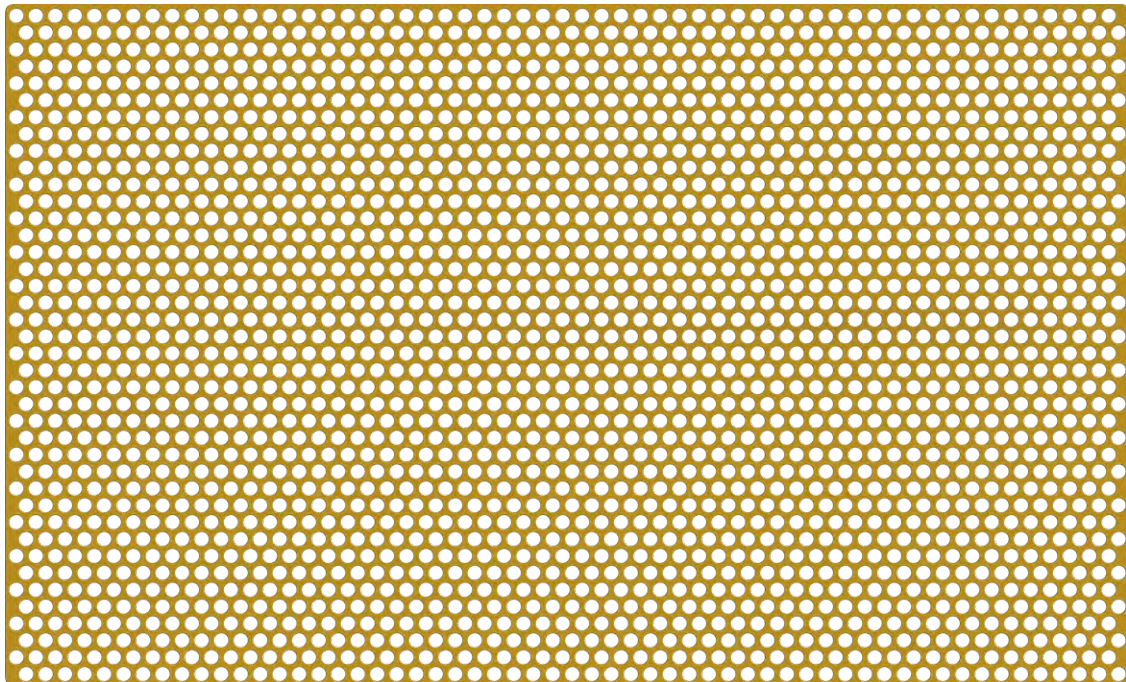

Nr katalogowy/Catalogue No./ № по кат.

grubość thickness толщина	0,1	3.7352.000
	0,2	3.7355.000
wymiar/size/измерение		90x150

**CZASZKA
 CRANIUM
 ЧЕРЕП**

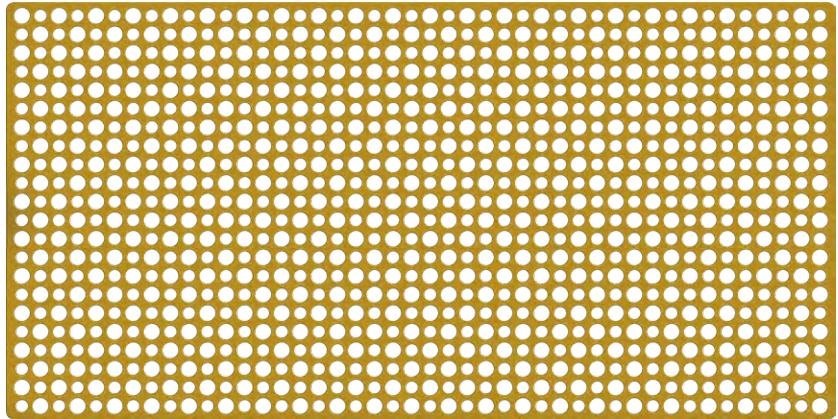
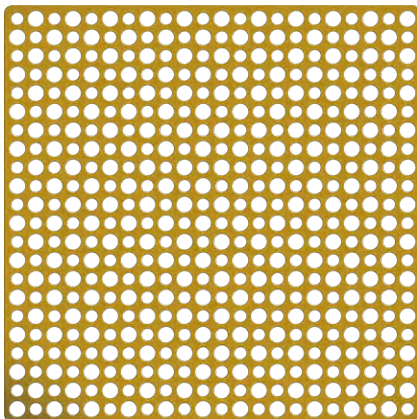

			Nr katalogowy/Catalogue No./№ по кат.	
grubość/ thickness/ толщина	MALLEABLE	0,3	3.7356.000	3.7357.000
	RIGID		3.7356.300	3.7357.300
wymiar/size/измерение			55x55	55x110

* płytki kompatybilne z systemem 2,0ChMP
 plates compatible with 2.0ChMP system
 Пластины совместимы с системой 2,0ChMP

CZASZKA
CRANIUM
ЧЕРЕП

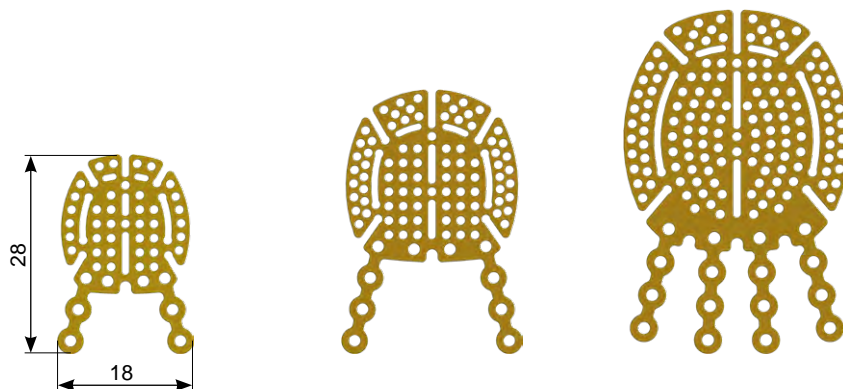

Nr katalogowy/Catalogue No./№ по кат.

grubość/ thickness/ толщина	MALLEABLE	0,3	3.6881.000	3.6882.000	3.6883.000
	RIGID				
			3.6881.300	3.6882.300	3.6883.300
wymiar/size/измерение			18x28	24x37	30x45,5



Al

Przymiar/Trial/Мера

Nr katalogowy/Catalogue No./№ по кат.

grubość/thickness/ толщина	0,2	43.6881.000	43.6882.000	43.6883.000
		18x19,5	24x24	30x32

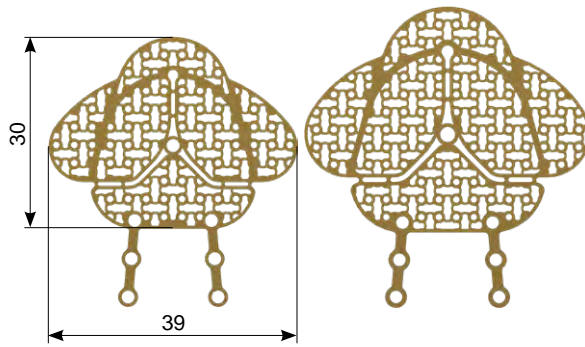

Nr katalogowy/Catalogue No./№ по кат.

grubość/ thickness/ толщина	MALLEABLE	0,4	3.7358.000	3.7359.000
	RIGID		3.7358.300	3.7359.300
wymiar/size/измерение			39x30	46x36
otwory/holes/отверстия			6	6

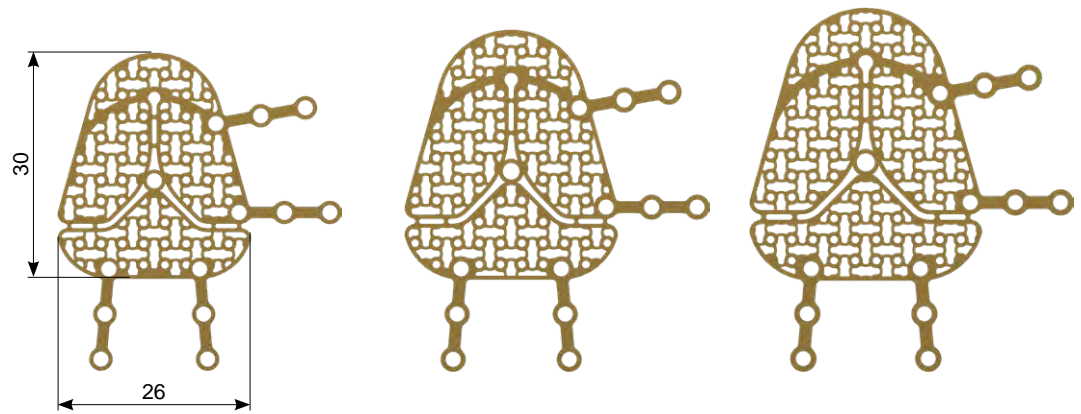

Nr katalogowy/Catalogue No./№ по кат.

grubość/ thickness/ толщина	MALLEABLE	0,3	3.6884.000	3.6885.000	3.6886.000
	RIGID		3.6884.300	3.6885.300	3.6886.300
wymiar/size/измерение			26x30	28,5x33	31x36
otwory/holes/отверстия			12	12	12

Wkładka na płytki ChMP 1/2
Insert for ChMP plates 1/2
Вкладыш для пластин ChMP 1/2

40.6446.204



Do umieszczenia w Paletcie ChMP 40.6444.000
For insertion in ChMP Palette 40.6444.000
Для размещения на Поддоне ChMP 40.6444.000



Nr katalogowy/Catalogue No./№ по кат.

grubość/ thickness/ толщина	MALLEABLE	0,4	3.7358.100	3.7359.100
	RIGID		3.7358.400	3.7359.400
wymiar/size/измерение			39x30	46x36
otwory/holes/отверстия			7	7

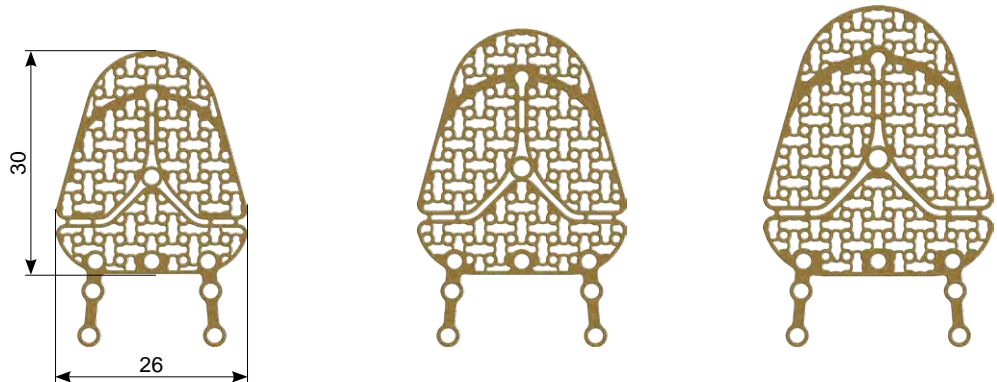

Nr katalogowy/Catalogue No./№ по кат.

grubość/ thickness/ толщина	MALLEABLE	0,3	3.6884.100	3.6885.100	3.6886.100
	RIGID		3.6884.400	3.6885.400	3.6886.400
wymiar/size/измерение			26x30	28,5x33	31x36
otwory/holes/отверстия			7	7	7



Al

Przymiar/Trial/Мера

Nr katalogowy/Catalogue No./№ по кат.

grubość/thickness/ толщина	0,2	43.6884.000	43.6885.000	43.6886.000
wymiar/size/измерение		26x30	28,5x33	31x36
Przymiar/Trial/Мера		3.6884, 3.7358	3.6885	3.6886, 3.7359



		Nr katalogowy/Catalogue No./№ по кат.	
grubość/thickness толщина	0,6	3.3346.002	3.3348.002
otwory/holes/отверстия		2	2
wymiar/size/измерение		11	15



		Nr katalogowy/Catalogue No./№ по кат.		
grubość/thickness толщина	0,4	3.4776.009	3.4776.012	3.4776.016
otwory/holes/отверстия		2	2	2
wymiar/size/измерение		13	16	20



		Nr katalogowy/Catalogue No./ № по кат.
grubość/thickness толщина	0,4	3.4784.004
otwory/holes/отверстия		4
wymiar/size/измерение		24



		Nr katalogowy/Catalogue No./ № по кат.			
grubość/thickness толщина	0,4	3.4783.007	3.4783.008	3.4783.016	3.4783.020
otwory/holes/отверстия		7	8	16	20
wymiar/size/измерение		28	32	64	80



		Nr katalogowy/Catalogue No./№ по кат.	
grubość/thickness толщина	0,4	3.4778.004	3.4778.013
otwory/holes/отверстия		4	4
wymiar/size/измерение		13	17



		Nr katalogowy/Catalogue No./№ по кат.		
grubość/thickness толщина	0,4	3.4781.006	3.4785.006	3.4786.006
otwory/holes/отверстия		6	6	6
wymiar/size/измерение		10x16,5	10x18	10x21



		Nr katalogowy/Catalogue No./ № по кат.
grubość/thickness толщина	0,4	3.4782.005
otwory/holes/отверстия		5
wymiar/size/измерение		10x19



Nr katalogowy/Catalogue No./ № по кат.

grubość/thickness толщина	0,4	3.4780.004	3.4788.004
otwory/holes/отверстия		4	4
wymiar/size/измерение		9x14	10x16

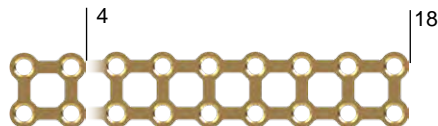

Nr katalogowy/Catalogue No./ № по кат.

grubość/thickness толщина	0,4	3.4779.004	3.4777.018
otwory/holes/отверстия		4	18
wymiar/size/измерение		10x10	10x52

ORTOGNATYKA
ORTHOGNATHIC
ОРТОГНАТИЯ

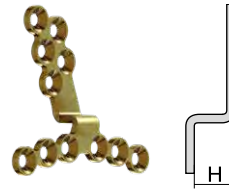

Nr katalogowy/Catalogue No./ № по кат.

grubość/ thickness толщина	1,0	L	3.4714.000	3.4714.003	3.4714.005	3.4714.007	3.4714.009	3.4714.011
			R	3.4715.000	3.4715.003	3.4715.005	3.4715.007	3.4715.009
otwory/holes/отверстия			11	11	11	11	11	11
wymiar/size/измерение H			0	3	5	7	9	11

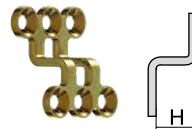

Nr katalogowy/Catalogue No./ № по кат.

grubość/thickness толщина	1,0	3.4716.001	3.4716.003	3.4716.005	3.4716.007	3.4716.009	3.4716.011
		otwory/holes/отверстия		6	6	6	6
wymiar/size/измерение H		1	3	5	7	9	11

ORTOGNATYKA
ORTHOGNATHIC
ОРТОГНАТИЯ

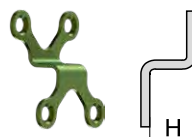

		Nr katalogowy/Catalogue No./ № по кат.					
grubość/thickness толщина	0,6	3.3811.002	3.3811.004	3.3811.006	3.3811.008	3.3811.010	3.3811.012
otwory/holes/отверстия		4	4	4	4	4	4
wymiar/size/измерение H		2	4	6	8	10	12

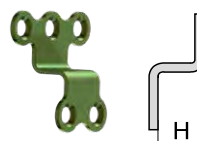

		Nr katalogowy/Catalogue No./ № по кат.					
grubość/thickness толщина	0,6	3.4466.002	3.4466.004	3.4466.006	3.4466.008	3.4466.010	3.4466.012
otwory/holes/отверстия		5	5	5	5	5	5
wymiar/size/измерение H		2	4	6	8	10	12

Wkładka na płytki ChMP 1/2
Insert for ChMP plates 1/2
Вкладыш для пластин ChMP 1/2

40.6446.304



Do umieszczenia w Palecie ChMP 40.6444.000
For insertion in ChMP Palette 40.6444.000
Для размещения на Поддоне ChMP 40.6444.000

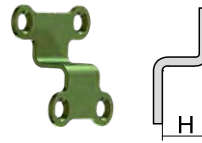

Nr katalogowy/Catalogue No./ № по кат.

grubość/thickness толщина	0,6	3.3810.002	3.3810.004	3.3810.006	3.3810.008	3.3810.010	3.3810.012
otwory/holes/отверстия		4	4	4	4	4	4
wymiar/size/измерение H		2	4	6	8	10	12

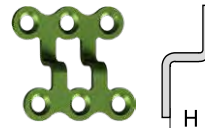

Nr katalogowy/Catalogue No./ № по кат.

grubość/thickness толщина	0,6	3.6849.003	3.6849.005	3.6849.007
otwory/holes/отверстия		6	6	6
wymiar/size/измерение H		3	5	7

ORTOGNATYKA
ORTHOGNATHIC
ОРТОГНАТИЯ



		Nr katalogowy/Catalogue No./№ по кат.		
grubość/thickness толщина	0,6	3.3801.119	3.3801.024	3.3801.030
	1,0	3.3085.119	3.3085.024	3.3085.030
otwory/holes/отверстия		4	4	4
wymiar/size/измерение		21	29	35

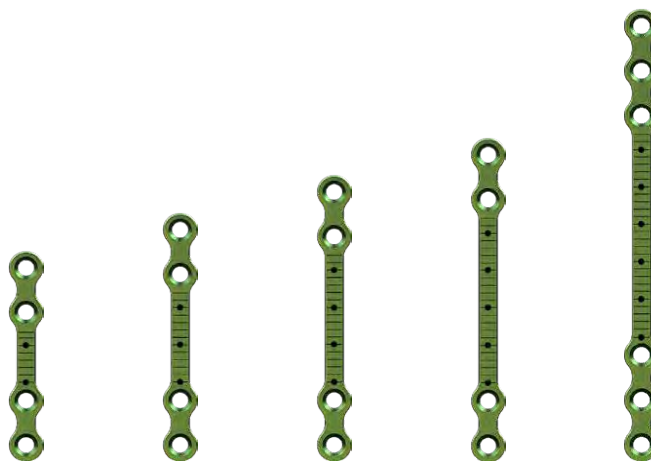

		Nr katalogowy/Catalogue No./№ по кат.				
grubość/thickness толщина	1,0	3.4729.028	3.4729.033	3.4729.038	3.4729.043	3.4730.060
otwory/holes/отверстия		4	4	4	4	6
wymiar/size/измерение		28	33	38	43	60

ORTOGNATYKA
ORTHOGNATHIC
ОРТОГНАТИЯ



		Nr katalogowy/Catalogue No./№ по кат.		
grubość/thickness толщина	0,6	3.4460.006	3.4462.006	3.4464.006
	1,0	3.4461.006	3.4463.006	3.4465.006
otwory/holes/отверстия		6	6	6
wymiar/size/измерение		29	32	35



			Nr katalogowy/Catalogue No./№ по кат.		
L/R	grubość/ thickness толщина	0,6	3.4731.026	3.4731.030	3.4731.034
		0,8	3.4769.026	3.4769.030	3.4769.034
		1,0	3.4732.026	3.4732.030	3.4732.034
otwory/holes/отверстия			4	4	4
wymiar/size/измерение			26	30	34



			Nr katalogowy/Catalogue No./№ по кат.			
L/R	grubość/ thickness толщина	0,6	3.4733.026	3.4733.030	3.4733.034	3.4733.038
		0,8	3.4770.026	3.4770.030	3.4770.034	3.4770.038
		1,0	3.4734.026	3.4734.030	3.4734.034	3.4734.038
otwory/holes/отверстия			4	4	4	4
wymiar/size/измерение			26	30	34	38

ORTOGNATYKA
ORTHOGNATHIC
ОРТОГНАТИЯ



			Nr katalogowy/Catalogue No./№ по кат.			
L/R	grubość/ thickness толщина	0,6	3.4735.026	3.4735.030	3.4735.034	3.4735.038
		0,8	3.4771.026	3.4771.030	3.4771.034	3.4771.038
		1,0	3.4736.026	3.4736.030	3.4736.034	3.4736.038
otwory/holes/отверстия			4	4	4	4
wymiar/size/измерение			26	30	34	38

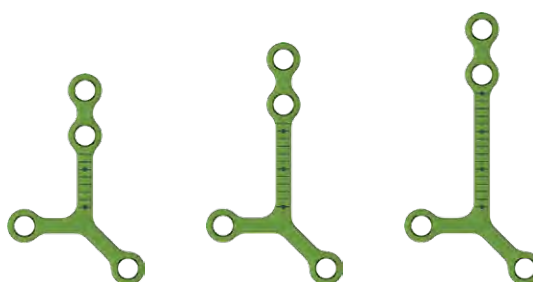

			Nr katalogowy/Catalogue No./№ по кат.		
L/R	grubość/ thickness толщина	0,6	3.6834.028	3.6834.032	3.6834.036
		0,8	3.6835.028	3.6835.032	3.6835.036
		1,0	3.6836.028	3.6836.032	3.6836.036
otwory/holes/отверстия			4	4	4
wymiar/size/измерение			28	32	36

ORTOGNATYKA
ORTHOGNATHIC
ОРТОГНАТИЯ



Nr katalogowy/Catalogue No./№ по кат.

grubość/thickness толщина	0,6	3.6828.023	3.6828.027	3.6828.031
	0,8	3.6829.023	3.6829.027	3.6829.031
	1,0	3.6830.023	3.6830.027	3.6830.031
otwory/holes/отверстия		4	4	4
wymiar/size/измерение		23	27	31



Nr katalogowy/Catalogue No./№ по кат.

L/R	grubość/ thickness толщина	0,6	3.6831.023	3.6831.027	3.6831.031
		0,8	3.6832.023	3.6832.027	3.6832.031
		1,0	3.6833.023	3.6833.027	3.6833.031
otwory/holes/отверстия		4	4	4	
wymiar/size/измерение		23	27	31	



ORTOGNATYKA
ORTHOGNATHIC
ОРТОГНАТИЯ



Nr katalogowy/Catalogue No./№ по кат.

grubość/thickness толщина	1,0	3.4737.028	3.4738.028
otwory/holes/отверстия		8	8
wymiar/size/измерение		28	28



Nr katalogowy/Catalogue No./№ по кат.

grubość/thickness толщина	1,0	3.4737.031	3.4738.031
otwory/holes/отверстия		8	8
wymiar/size/измерение		31	31



Nr katalogowy/Catalogue No./№ по кат.

grubość/thickness толщина	1,0	3.4737.034	3.4738.034
otwory/holes/отверстия		8	8
wymiar/size/измерение		34	34

Wkładka na płytki ChMP 2/2
Insert for ChMP plates 2/2
Вкладыш для пластин ChMP 2/2

40.6446.005



Do umieszczenia w Paletce ChMP 40.6444.000
For insertion in ChMP Palette 40.6444.000
Для размещения на Поддоне ChMP 40.6444.000

ORTOGNATYKA
ORTHOGNATHIC
ОРТОГНАТИЯ



Nr katalogowy/Catalogue No./№ по кат.

grubość/thickness толщина	1,0	3.4793.006	3.4794.006
otwory/holes/отверстия		6	6
wymiar/size/измерение		17x29	17x29

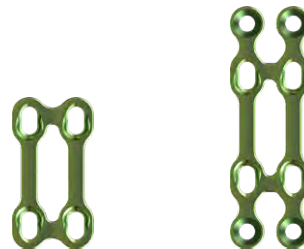

Nr katalogowy/Catalogue No./№ по кат.

grubość/thickness толщина	1,0	3.6802.004	3.6803.008
otwory/holes/отверстия		4	8
wymiar/size/измерение		11x20	11x32

ORTOGNATYKA
ORTHOGNATHIC
ОРТОГНАТИЯ



		Nr katalogowy/Catalogue No./№ по кат.
grubość/thickness толщина	1,0	3.6804.004
otwory/holes/отверстия		4
wymiar/size/измерение		26



		Nr katalogowy/Catalogue No./№ по кат.
grubość/thickness толщина	1,0	3.6805.008
otwory/holes/отверстия		8
wymiar/size/измерение		50



		Nr katalogowy/Catalogue No./№ по кат.
grubość/thickness толщина	1,0	3.6806.008
otwory/holes/отверстия		8
wymiar/size/измерение		53



		Nr katalogowy/Catalogue No./№ по кат.
grubość/thickness толщина	1,0	3.6807.010
otwory/holes/отверстия		10
wymiar/size/измерение		68

ORTOGNATYKA
ORTHOGNATHIC
ОРТОГНАТИЯ



Nr katalogowy/Catalogue No./№ по кат.

grubość/thickness толщина	1,0	3.6808.006
otwory/holes/отверстия		6
wymiar/size/измерение		41



Nr katalogowy/Catalogue No./№ по кат.

grubość/thickness толщина	1,0	3.6809.006
otwory/holes/отверстия		6
wymiar/size/измерение		41

L [mm] [MM]	Nr katalogowy Catalogue no. № по кат.			
	Ø1,5			
	□1,2		+	
3	3.1015.003	3.1015.503	3.6650.003	3.6650.503
4	3.1015.004	3.1015.504	3.6650.004	3.6650.504
5	3.1015.005	3.1015.505	3.6650.005	3.6650.505
6	3.1015.006	3.1015.506	3.6650.006	3.6650.506
7	3.1015.007	3.1015.507	3.6650.007	3.6650.507
8	3.1015.008	3.1015.508	3.6650.008	3.6650.508
9	3.1015.009	3.1015.509	3.6650.009	3.6650.509
10	3.1015.010	3.1015.510	3.6650.010	3.6650.510
11	3.1015.011	3.1015.511	3.6650.011	3.6650.511
12	3.1015.012	3.1015.512	3.6650.012	3.6650.512
13	3.1015.013	3.1015.513	3.6650.013	3.6650.513
14	3.1015.014	3.1015.514	3.6650.014	3.6650.514
15	3.1015.015	3.1015.515	3.6650.015	3.6650.515
16	3.1015.016	3.1015.516	3.6650.016	3.6650.516
Szt. Pcs Шт.	1	5	1	5

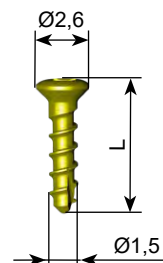

samogwintujący
self - tapping
самонарезающий

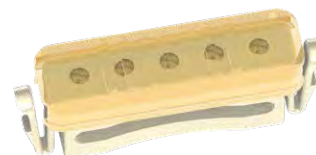

L [mm] [MM]	Nr katalogowy Catalogue no. № по кат.			
	Ø1,8 AWARYJNY, EMERGENCY АВАРИЙНЫЕ			
	□1,2		+	
5	3.1023.005	3.1023.505	3.6651.005	3.6651.505
7	3.1023.007	3.1023.507	3.6651.007	3.6651.507
9	3.1023.009	3.1023.509	3.6651.009	3.6651.509
11	3.1023.011	3.1023.511	3.6651.011	3.6651.511
13	3.1023.013	3.1023.513	3.6651.013	3.6651.513
15	3.1023.015	3.1023.515	3.6651.015	3.6651.515
17	3.1023.017	3.1023.517	3.6651.017	3.6651.517
20	3.1023.020	3.1023.520	3.6651.020	3.6651.520
Szt. Pcs Шт.	1	5	1	5

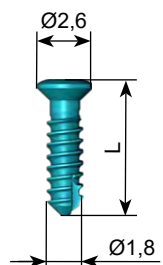

samogwintujący
self - tapping
самонарезающий

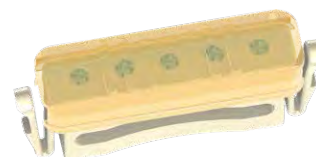

L [mm] [MM]	Nr katalogowy Catalogue no. № по кат.			
	Ø1,5			
	□1,2		+	
3			3.6653.003	3.6653.503
4	3.1025.004	3.1025.504	3.6653.004	3.6653.504
5	3.1025.005	3.1025.505	3.6653.005	3.6653.505
6	3.1025.006	3.1025.506	3.6653.006	3.6653.506
7	3.1025.007	3.1025.507	3.6653.007	3.6653.507
8	3.1025.008	3.1025.508	3.6653.008	3.6653.508
9	3.1025.009	3.1025.509	3.6653.009	3.6653.509
Szt. Pcs Шт.	1	5	1	5

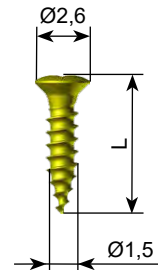

samowiercący
self - drilling
самосверлящий

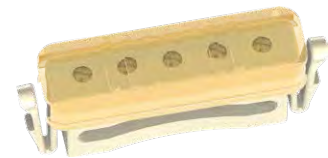

L [mm] [мм]	Nr katalogowy Catalogue no. № по кат.	
	Ø1,5 LOW PROFILE	
		
3	3.6680.003	3.6680.503
4	3.6680.004	3.6680.504
5	3.6680.005	3.6680.505
Szt. Pcs Шт.	1	5

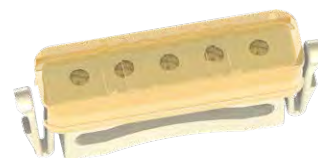
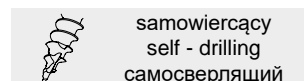
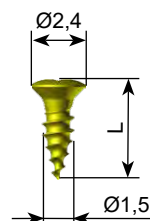

L [mm] [мм]	Nr katalogowy Catalogue no. № по кат.	
	Ø1,8 LOW PROFILE AWARYJNY EMERGENCY, АВАРИЙНЫЕ	
		
3	3.6681.003	3.6681.503
4	3.6681.004	3.6681.504
5	3.6681.005	3.6681.505
Szt. Pcs Шт.	1	5

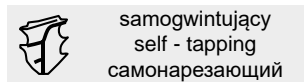
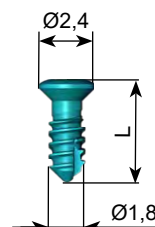

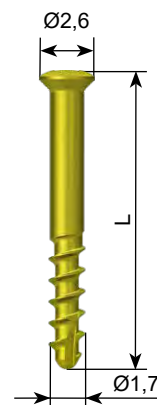

Nr katalogowy Catalogue no. № по кат.		
L [mm] [MM]	Ø1,7 LAG SCREW	
	 □1,2	
14	3.1037.014	3.1037.514
16	3.1037.016	3.1037.516
18	3.1037.018	3.1037.518
Szt. Pcs Шт.	1	5

* Opcjonalne narzędzia do wkrętów kompresyjnych – Wiertła stopniowe 1,25/1,7-14÷18 [40.6439.014÷018];
Optional instruments for compression screws – Gradual drills 1.25/1.7-14÷18 [40.6439.014÷018];
Инструменты для компрессионных винтов – опционально - Сверло фазное 1,25/1,7-14÷18 [40.6439.014÷018];

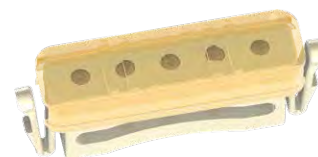

samogwintujący
self - tapping
самонарезающий



Nr katalogowy Catalogue no. № по кат.				
L [mm] [MM]	Ø1,7		Ø1,8	
	 □1,2			
10	3.1030.010	3.1030.510	3.6658.010	3.6658.510
12	3.1030.012	3.1030.512	3.6658.012	3.6658.512
14	3.1030.014	3.1030.514	3.6658.014	3.6658.514
16	3.1030.016	3.1030.516	3.6658.016	3.6658.516
18	3.1030.018	3.1030.518	3.6658.018	3.6658.518
Szt. Pcs Шт.	1	5	1	5

* Opcjonalne narzędzia do wkrętów kompresyjnych – Wiertła stopniowe 1,2-10÷18[40.8424.010÷018];
Optional instruments for compression screws – Gradual drills 1.2-10÷18 [40.8424.010÷018];
Инструменты для компрессионных винтов – опционально - Сверло фазное 1,2-10÷18 [40.8424.010÷018];

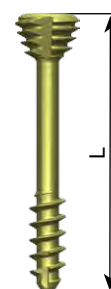

samogwintujący
self - tapping
самонарезающий

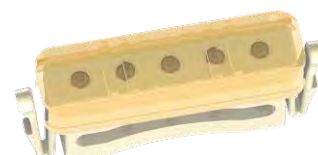

Nr katalogowy Catalogue no. № по кат.		
L [mm] [MM]	Ø1,5 TENTING	
7	3.1038.007	3.1038.507
8	3.1038.008	3.1038.508
9	3.1038.009	3.1038.509
10	3.1038.010	3.1038.510
11	3.1038.011	3.1038.511
12	3.1038.012	3.1038.512
13	3.1038.013	3.1038.513
14	3.1038.014	3.1038.514
16	3.1038.016	3.1038.516
Szt. Pcs Шт.	1	5

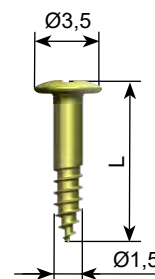

samowiercący
self - drilling
самосверлящий



Nr katalogowy Catalogue no. № по кат.		
L [mm] [MM]	Ø1,5 MEMBRANE	
3	3.1034.003	3.1034.503
5	3.1034.005	3.1034.505
Szt. Pcs Шт.	1	5

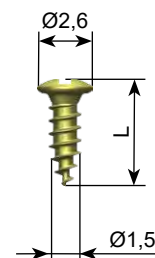

samowiercący
self - drilling
самосверлящий

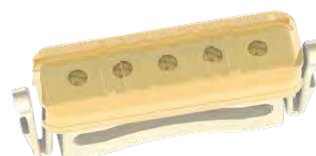

Moduł na wkręty ChMP 3/10
Module for ChMP screws 3/10
Модуль для винтов ChMP 3/10 **40.6445.201**

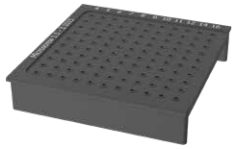

3.1015.004÷016
3.6650.004÷016

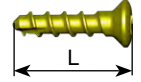

L [mm/ MM]	4	5	6	7	8	9	10	11	12	14	16
Szt.	10	10	10	10	10	10	10	10	10	10	10

Moduł na wkręty ChMP 3/10
Module for ChMP screws 3/10
Модуль для винтов ChMP 3/10 **40.6445.204**

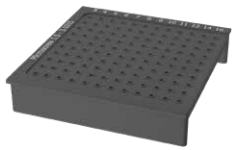

3.1015.003÷016
3.6650.003÷016

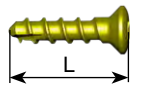

L [mm/ MM]	3	4	5	6	7	8	9	10	11	12	14	16
Szt.	10	10	10	10	10	10	10	10	10	10	10	10

Moduł na wkręty ChMP 1/10
Module for ChMP screws 1/10
Модуль для винтов ChMP 1/10 **40.6445.202**



3.1023.005÷009
3.6651.005÷009

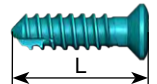

L [mm/ MM]	5	7	9
Szt.	10	10	10

Moduł na wkręty ChMP 2/10
Module for ChMP screws 2/10
Модуль для винтов ChMP 2/10 **40.6445.205**

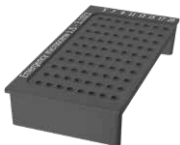

3.1023.005÷020
3.6651.005÷020

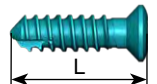

L [mm/ MM]	5	7	9	11	13	15	17	20
Szt.	10	10	10	10	10	10	10	10

Moduł na wkręty ChMP 2/10
Module for ChMP screws 2/10
Модуль для винтов ChMP 2/10 **40.6445.203**

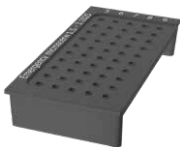

3.1025.005÷009
3.6653.005÷009

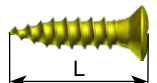

L [mm/ MM]	5	6	7	8	9
Szt.	10	10	10	10	10

Moduł na wkręty ChMP 2/10
Module for ChMP screws 2/10
Модуль для винтов ChMP 2/10 **40.6445.206**

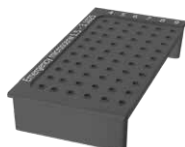

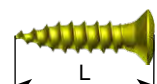

3.1025.004÷009
3.6653.004÷009



L [mm/ MM]	4	5	6	7	8	9
Szt.	10	10	10	10	10	10

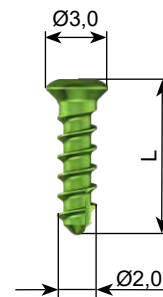

Do umieszczenia w Palecie ChMP 40.6444.000
For insertion in ChMP Palette 40.6444.000
Для размещения на Поддоне ChMP 40.6444.000

L [mm] [мм]	Nr katalogowy Catalogue no. № по кат.			
	Ø2,0			
	 □1,2			
4	3.1145.004	3.1145.504	3.6660.004	3.6660.504
5	3.1145.005	3.1145.505	3.6660.005	3.6660.505
6	3.1145.006	3.1145.506	3.6660.006	3.6660.506
7	3.1145.007	3.1145.507	3.6660.007	3.6660.507
8	3.1145.008	3.1145.508	3.6660.008	3.6660.508
9	3.1145.009	3.1145.509	3.6660.009	3.6660.509
10	3.1145.010	3.1145.510	3.6660.010	3.6660.510
11	3.1145.011	3.1145.511	3.6660.011	3.6660.511
12	3.1145.012	3.1145.512	3.6660.012	3.6660.512
13	3.1145.013	3.1145.513	3.6660.013	3.6660.513
14	3.1145.014	3.1145.514	3.6660.014	3.6660.514
15	3.1145.015	3.1145.515	3.6660.015	3.6660.515
16	3.1145.016	3.1145.516	3.6660.016	3.6660.516
17	3.1145.017	3.1145.517	3.6660.017	3.6660.517
18	3.1145.018	3.1145.518	3.6660.018	3.6660.518
19			3.6660.019	3.6660.519
Szt. Pcs Шт.	1	5	1	5

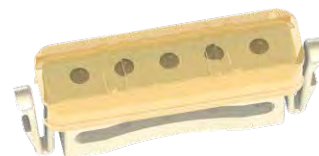

 samogwintujący
self - tapping
самонарезающий



L [mm] [мм]	Nr katalogowy Catalogue no. № по кат.			
	Ø2,3 AWARYJNY, EMERGENCY, АВАРИЙНЫ			
	 □1,2			
4	-	-	3.6661.004	3.6661.504
5	-	-	3.6661.005	3.6661.505
6	3.1153.006	3.1153.506	3.6661.006	3.6661.506
7	-	-	3.6661.007	3.6661.507
8	3.1153.008	3.1153.508	3.6661.008	3.6661.508
9	-	-	3.6661.009	3.6661.509
10	3.1153.010	3.1153.510	3.6661.010	3.6661.510
12	3.1153.012	3.1153.512	3.6661.012	3.6661.512
14	3.1153.014	3.1153.514	3.6661.014	3.6661.514
16	3.1153.016	3.1153.516	3.6661.016	3.6661.516
18	3.1153.018	3.1153.518	3.6661.018	3.6661.518
Szt. Pcs Шт.	1	5	1	5

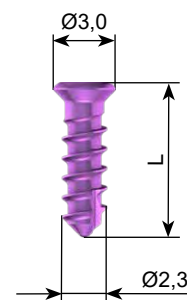

 samogwintujący
self - tapping
самонарезающий

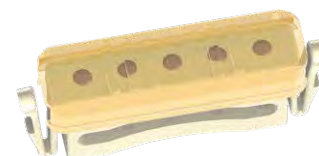

L [mm] [MM]	Nr katalogowy Catalogue no. № по кат.			
	Ø2,0			
	□1,2		+	
5	3.1026.005	3.1026.505	3.6663.005	3.6663.505
6	3.1026.006	3.1026.506	3.6663.006	3.6663.506
7	3.1026.007	3.1026.507	3.6663.007	3.6663.507
8	3.1026.008	3.1026.508	3.6663.008	3.6663.508
9	-	-	3.6663.009	3.6663.509
10	3.1026.010	3.1026.510	3.6663.010	3.6663.510
12	3.1026.012	3.1026.512	3.6663.012	3.6663.512
14	3.1026.014	3.1026.514	3.6663.014	3.6663.514
16	3.1026.016	3.1026.516	3.6663.016	3.6663.516
Szt. Pcs Шт.	1	5	1	5

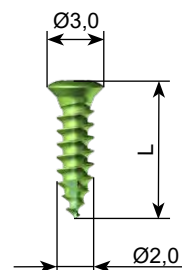

 samowiercący
self - drilling
самосверлящий

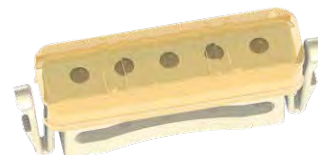

L [mm] [MM]	Nr katalogowy Catalogue no. № по кат.			
	Ø2,0 LAG SCREW			
	□1,2		+	
14	3.1027.014	3.1027.514	3.6662.014	3.6662.514
16	3.1027.016	3.1027.516	3.6662.016	3.6662.516
18	3.1027.018	3.1027.518	3.6662.018	3.6662.518
Szt. Pcs Шт.	1	5	1	5

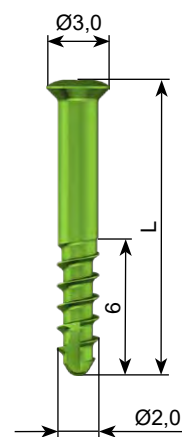



 samogwintujący
self - tapping
самонарезающий

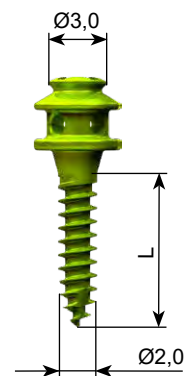

* Opcjonalne narzędzia do wkrętów kompresyjnych – Wiertła stopniowe 1,6/2,0 [40.6427.014÷018]; [40.6427.614÷618]
Optional instruments for compression screws – Gradual drills 1.6/2.0 [40.6427.014÷018]; [40.6427.614÷618]
Инструменты для компрессионных винтов – опционально - Сверло фазное 1,6/2,0 [40.6427.014÷018]; [40.6427.614÷618]

L [mm] [MM]	Nr katalogowy Catalogue no. № по кат.			
	Ø2,0 IMF			
	□1,2		+	
8	1.1024.008	1.1024.508	3.6664.008	3.6664.508
10	1.1024.010	1.1024.510	3.6664.010	3.6664.510
11	-	-	3.6664.011	3.6664.511
12	1.1024.012	1.1024.512	3.6664.012	3.6664.512
14			3.6664.014	3.6664.514
Szt. Pcs Шт.	1	5	1	5
	St			



 samowierzący
self - drilling
самосверлящий

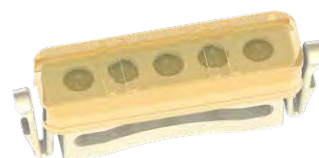

L [mm] [MM]	Nr katalogowy Catalogue no. № по кат.	
	Ø2,0 IMF	
	+	
8	3.6665.008	3.6665.508
10	3.6665.010	3.6665.510
11	3.6665.011	3.6665.511
12	3.6665.012	3.6665.512
14	3.6665.014	3.6665.514
Szt. Pcs Шт.	1	5

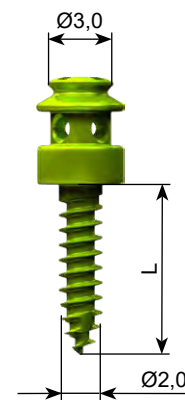

 samowierzący
self - drilling
самосверлящий

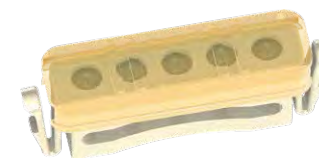

Moduł na wkręty ChMP 3/10
Module for ChMP screws 3/10
Модуль для винтов ChMP 3/10

40.6445.301

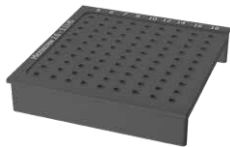

3.1145.005÷018
3.6660.005÷018



L [mm/ MM]	5	6	7	8	10	12	14	16	18
Szt.	10	10	10	10	10	10	10	10	10

Moduł na wkręty ChMP 2/10
Module for ChMP screws 2/10
Модуль для винтов ChMP 2/10

40.6445.302

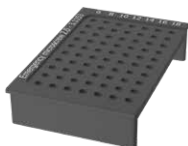

3.1153.006÷018
3.6661.006÷018

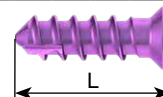

L [mm/ MM]	6	8	10	12	14	16	18
Szt.	10	10	10	10	10	10	10

Moduł na wkręty ChMP 1/10
Module for ChMP screws 1/10
Модуль для винтов ChMP 1/10

40.6445.303

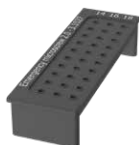

3.1027.014÷018
3.6662.014÷018



L [mm/ MM]	14	16	18
Szt.	10	10	10

Moduł na wkręty ChMP 2/10
Module for ChMP screws 2/10
Модуль для винтов ChMP 2/10

40.6445.304

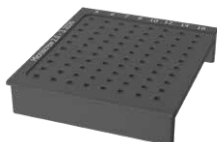

3.1026.005÷016
3.6663.005÷016

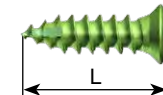

L [mm/ MM]	5	6	7	8	10	12	14	16
Szt.	10	10	10	10	10	10	10	10

Moduł na wkręty ChMP 1/10
Module for ChMP screws 1/10
Модуль для винтов ChMP 1/10

40.6445.305



1.1024.008÷012
3.1024.008÷012
1.6664.008÷012
3.6664.008÷012

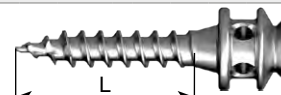

L [mm/ MM]	8	10	12
Szt.	10	10	10

Do umieszczenia w Palecie ChMP 40.6444.000
For insertion in ChMP Palette 40.6444.000
Для размещения на Поддоне ChMP 40.6444.000

**PALETA BAZOWA NA IMPLANTY
BASIC TRAY FOR IMPLANTS
ОСНОВНОЙ ПОДДОН ДЛЯ ИМПЛАНТАТОВ**

**Paleta ChMP
ChMP palette
Поддон ChMP**

40.6444.000



**PRZYKŁAD ROZMIESZCZENIA MODUŁÓW I WKŁADEK
EXAMPLE OF MODULES AND INSERTS ARRANGEMENT
ПРИМЕР РАСПОЛОЖЕНИЯ МОДУЛЕЙ И ВКЛАДЫШЕЙ**

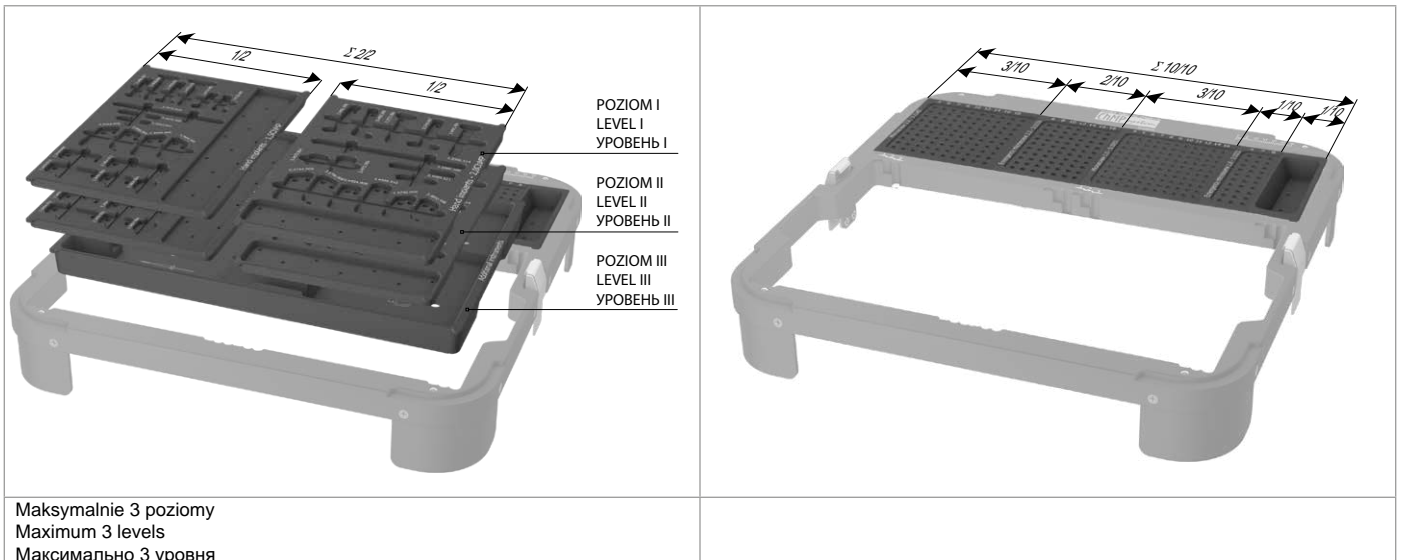

**MODUŁY UZUPEŁNIAJĄCE
COMPLETIVE MODULES
ДОПОЛНИТЕЛЬНЫЕ МОДУЛИ**

	Nazwa/Name/Название	Nr katalogowy Catalogue No. № по кат.	Szt. Pcs Шт.
	Moduł na wkręty ChMP 1/10 Module for ChMP screws 1/10 Модуль для винтов ChMP 1/10	40.6445.001	1
	Moduł na wkręty ChMP 2/10 Module for ChMP screws 2/10 Модуль для винтов ChMP 2/10	40.6445.002	1
	Moduł na wkręty ChMP 3/10 Module for ChMP screws 3/10 Модуль для винтов ChMP 3/10	40.6445.003	1
	Moduł na wkręty ChMP 10/10 Module for ChMP screws 10/10 Модуль для винтов ChMP 10/10	40.6445.004	1
Do umieszczenia w Palecie ChMP 40.6444.000 For insertion in ChMP Palette 40.6444.000 Для размещения на Поддоне ChMP 40.6444.000			

**WKŁADKI UZUPEŁNIAJĄCE
COMPLETIVE INSERTS
ДОПОЛНИТЕЛЬНЫЕ ВКЛАДЫШИ**

	Nazwa/Name/Название	Nr katalogowy Catalogue No. № по кат.	Szt. Pcs Шт.
	Wkładka na płytki ChMP 1/2 Insert for ChMP plates 1/2 Вкладыш для пластин ChMP 1/2	40.6446.001	1
	Wkładka na płytki ChMP 2/2 Insert for ChMP plates 2/2 Вкладыш для пластин ChMP 2/2	40.6446.002	1
Do umieszczenia w Palecie ChMP 40.6444.000 For insertion in ChMP Palette 40.6444.000 Для размещения на Поддоне ChMP 40.6444.000			

**INSTRUMENTARIA BAZOWE ChMP
BASIC ChMP INSTRUMENTS
ОСНОВНОЙ ИНСТРУМЕНТАРИЙ ChMP**

Instrumentarium ChMP ChMP instruments set Инструментарий ChMP		40.6440.004	40.6440.005	40.6440.006	40.6440.007	
	Nazwa/Name/Название	Nr katalogowy Catalogue No. № по кат.				Szt. Pcs Шт.
	Paleta na instrumentarium ChMP Palette for ChMP instrument set Поддон для инструментов ChMP	40.6441.000				1
	Kleszcze do cięcia drutu Hercules HERCULES forceps for wire cutting Щипцы дрезания проволоки Hercules 23cm	30.4172.000				1
	Szczypce do cięcia płytek Plate cutting pliers Клещи для резания пластин		40.4650.000			1
	Szczypce do cięcia płytek Plate cutting pliers Клещи для резания пластин			40.8406.000		1
	Szczypce do cięcia płytek 12cm Plate cutting pliers 12 cm Клещи для резания пластин 12cm				40.6426.000	1
	Pinceta do płytek – odgięta Plate forceps – curved Пинцет для пластин - изогн		40.4651.000			1
	Szczypce do wyginania płytek Plate bending pliers Клещи для выгибания пластин 1,5/2,0/2,7		40.4642.000			2
	Rękojeść z szybkozłączem Quick coupling handle Рукоятка с быстроразъемным соединением		40.6405.100			1

**PRZYKŁAD ROZMIESZCZENIA WKŁADEK Z NARZĘDZIAMI ChMP
EXAMPLE OF INSERTS WITH ChMP INSTRUMENTS ARRANGEMENT
ПРИМЕР РАСПОЛОЖЕНИЯ ВКЛАДЫШЕЙ С ИНСТРУМЕНТАМИ ChMP**

POZIOM I
LEVEL I
УРОВЕНЬ I

POZIOM II
LEVEL II
УРОВЕНЬ II

Maksymalnie 2 poziomy
Maximum 2 levels
Максимально 2 уровня

WKŁADKI UZUPEŁNIAJĄCE Z NARZĘDZIAMI SYSTEMOWYMI
COMPLETIVE INSERTS WITH SYSTEM INSTRUMENTS
ДОПОЛНИТЕЛЬНЫЕ ВКЛАДЫШИ С ИНСТРУМЕНТАМИ СИСТЕМЫ

Wkładka z narzędziami ChMP Insert with ChMP instruments Вкладыш с инструментами ChMP		40.6442.204	40.6442.206	40.6442.205	
		Nr katalogowy Catalogue No. № по кат.			Szt. Pcs Шт.
		Nazwa/Name/Название			
		40.6443.204	40.6443.206	40.6443.205	1
		40.4645.015			1
		40.6449.001			1
		Wiertło/Drill/Сверло 1,25/4,0	40.6421.004	X	1
		Wiertło/Drill/Сверло 1,25/5,0	40.6421.005		1
		Wiertło/Drill/Сверло 1,25/7,0	40.6421.007		1
		Wiertło/Drill/Сверло 1,25/9,0	40.6421.009		1
		Wiertło/Drill/Сверло 1,25/15,0	40.6421.015		1
		Wiertło/Drill/Сверло 1,25/70	40.6424.070		1
		Wiertło/Drill/Сверло 1,5/70	40.6417.070		1
		Wiertło/Drill/Сверло 1,25/4,0	40.6421.604		X
Wiertło/Drill/Сверло 1,25/5,0	40.6421.605	1			
Wiertło/Drill/Сверло 1,25/7,0	40.6421.607	1			
Wiertło/Drill/Сверло 1,25/9,0	40.6421.609	1			
Wiertło/Drill/Сверло 1,25/15,0	40.6421.615	1			
Wiertło/Drill/Сверло 1,25/70	40.6424.670	1			
Wiertło/Drill/Сверло 1,5/70	40.6417.670	1			
		Wiertło/Drill/Сверло 1,25/4,0	X	40.6421.704	
		Wiertło/Drill/Сверло 1,25/5,0		40.6421.705	1
		Wiertło/Drill/Сверло 1,25/7,0		40.6421.707	1
		Wiertło/Drill/Сверло 1,25/9,0		40.6421.709	1
		Wiertło/Drill/Сверло 1,25/15,0		40.6421.715	1
		Wiertło/Drill/Сверло 1,25/20		40.6421.720	1
		Wiertło/Drill/Сверло 1,6/20		40.6422.720	1

Do umieszczenia w Instrumentarium ChMP 40.6440.xxx
 For insertion in ChMP Instruments set 40.6440.xxx
 Для размещения в Инструментарий ChMP 40.6440.xxx

WKŁADKI UZUPEŁNIAJĄCE Z NARZĘDZIAMI SYSTEMOWYMI
COMPLETIVE INSERTS WITH SYSTEM INSTRUMENTS
ДОПОЛНИТЕЛЬНЫЕ ВКЛАДЫШИ С ИНСТРУМЕНТАМИ СИСТЕМЫ

Wkładka z narzędziami ChMP Insert with ChMP instruments Вкладыш с инструментами ChMP		40.6442.304	40.6442.306	40.6442.305	
		Nr katalogowy Catalogue No. № по кат.			Szt. Pcs Шт.
Nazwa/Name/Название					
		40.6443.304	40.6443.306	40.6443.305	1
		40.4645.020			1
		40.6449.003			1
		Wiertło/Drill/Сверло 1,6/6,0	40.6422.006	X	1
		Wiertło/Drill/Сверло 1,6/8,0	40.6422.008		1
		Wiertło/Drill/Сверло 1,6/12,0	40.6422.012		1
		Wiertło/Drill/Сверло 1,6/20,0	40.6422.020		1
		Wiertło/Drill/Сверло 1,6/22/100	40.6423.022		1
		Wiertło/Drill/Сверло 2,0/22/100	40.6411.022	X	1
		Wiertło/Drill/Сверло 1,6/6,0	40.6422.606		1
		Wiertło/Drill/Сверло 1,6/8,0	40.6422.608		1
		Wiertło/Drill/Сверло 1,6/12,0	40.6422.612		1
		Wiertło/Drill/Сверло 1,6/20,0	40.6422.620		1
		Wiertło/Drill/Сверло 1,6/22/100	40.6423.622	X	1
		Wiertło/Drill/Сверло 2,0/22/100	40.6411.622		1
		Wiertło/Drill/Сверло 1,6/6,0	40.6422.706		1
		Wiertło/Drill/Сверло 1,6/8,0	40.6422.708		1
		Wiertło/Drill/Сверло 1,6/12,0	40.6422.712		1
		Wiertło/Drill/Сверло 1,6/20,0	40.6422.720	X	1
		Wiertło/Drill/Сверло 2,0/20,0	40.6411.720		1
Do umieszczenia w Instrumentarium ChMP 40.6440.xxx For insertion in ChMP Instruments set 40.6440.xxx Для размещения в Инструментарий ChMP 40.6440.xxx					

PRZYKŁADY KOMPLETACJI
EXAMPLES COMPLETION
ПРИМЕРЫ КОМПЛЕКТАЦИИ

PROPOZYCJA KOMPLETACJI ZESTAWU MODUŁOWEGO 1,5/2,0ChMP - DŁOŃ
EXEMPLARY ARRANGEMENT OF 1.5/2.0ChMP MODULAR SET – HAND
ВАРИАНТ КОМПЛЕКТАЦИИ МОДУЛЬНОГО НАБОРА 1,5/2,0ChMP - ЛАДОНЬ

INSTRUMENTARIUM 1,5/2,0 ChMP INSTRUMENT SET FOR 1.5/2.0ChMP ИНСТРУМЕНТАРИЙ 1,5/2,0 ChMP		STATYW NA IMPLANTY STAND FOR IMPLANTS ПОДСТАВКА ДЛЯ ИМПЛАНТАТОВ	
Nazwa/Name/Название	Nr katalogowy Catalogue No. № по кат.	Nazwa/Name/Название	Nr katalogowy Catalogue No. № по кат.
Instrumentarium ChMP ChMP instrument set Инструментарий ChMP	40.6440.004	Paleta ChMP ChMP palette Поддон ChMP	40.6444.000
Wkładka z narzędziami ChMP Insert with ChMP instruments Вкладыш с инструментами ChMP	40.6442.304	Moduł na wkręty ChMP 3/10 Module for ChMP screws 3/10 Модуль для винтов ChMP 3/10	40.6445.301
Wkładka z narzędziami ChMP Insert with ChMP instruments Вкладыш с инструментами ChMP	40.6442.204	Moduł na wkręty ChMP 2/10 Module for ChMP screws 2/10 Модуль для винтов ChMP 2/10	40.6445.302
		Moduł na wkręty ChMP 3/10 Module for ChMP screws 3/10 Модуль для винтов ChMP 3/10	40.6445.201
		Moduł na wkręty ChMP 1/10 Module for ChMP screws 1/10 Модуль для винтов ChMP 1/10	40.6445.202
		Moduł na wkręty ChMP 1/10 Module for ChMP screws 1/10 Модуль для винтов ChMP 1/10	40.6445.001
		Wkładka na płytki ChMP 1/2 Insert for ChMP plates 1/2 Вкладыш для пластин ChMP 1/2	40.6446.202
		Wkładka na płytki ChMP 1/2 Insert for ChMP plates 1/2 Вкладыш для пластин ChMP 1/2	40.6446.302
		Wkładka z narzędziami ChMP 2/2 Insert with ChMP instruments 2/2 Вкладыш с инструментами ChMP 2/2	40.6447.001

PRZYKŁADY KOMPLETACJI
EXAMPLES COMPLETION
ПРИМЕРЫ КОМПЛЕКТАЦИИ

PROPOZYCJA KOMPLETACJI ZESTAWU MODUŁOWEGO 2,0 ChMP - ACP
EXEMPLARY ARRANGEMENT OF 2.0ChMP- ACP
ВАРИАНТ КОМПЛЕКТАЦИИ МОДУЛЬНОГО НАБОРА 2,0 ChMP - ACP

INSTRUMENTARIUM 2,0ChMP
INSTRUMENT SET FOR 2.0ChMP
ИНСТРУМЕНТАРИЙ 2,0ChMP

STATYW NA IMPLANTY
STAND FOR IMPLANTS
ПОДСТАВКА ДЛЯ ИМПЛАНТАТОВ

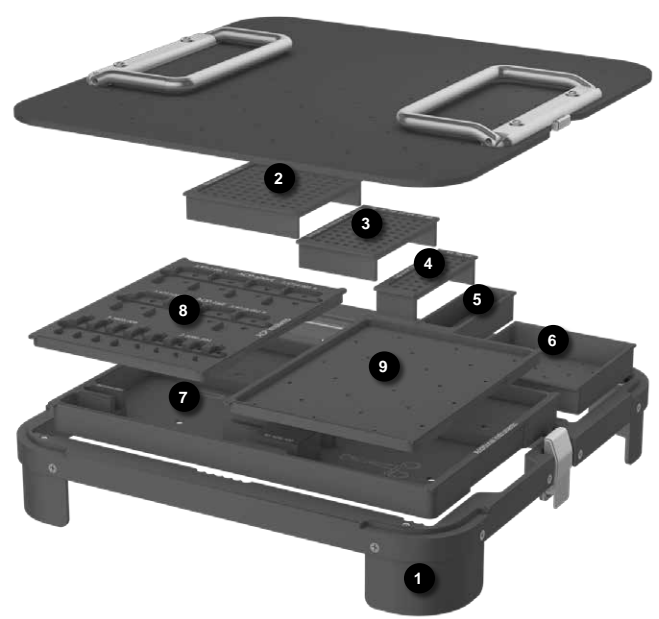
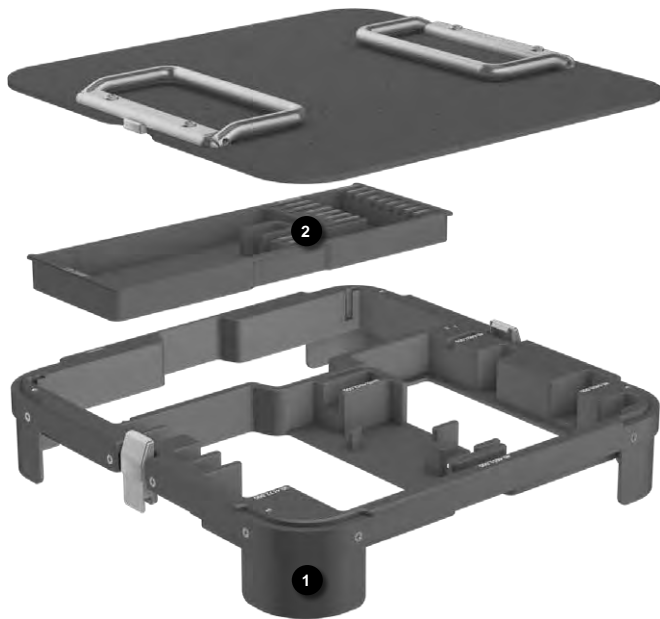

Nazwa/Name/Название

Nr katalogowy Catalogue No.
№ по кат.

Nazwa/Name/Название

Nr katalogowy Catalogue No.
№ по кат.

Instrumentarium ChMP
ChMP instrument set
Инструментарий ChMP

40.6440.004

Paleta ChMP
ChMP palette
Поддон ChMP

40.6444.000

Wkładka z narzędziami ChMP
Insert with ChMP instruments
Вкладыш с инструментами ChMP

40.6442.304

lub/или

40.6442.305

Moduł na wkręty ChMP 3/10
Module for ChMP screws 3/10
Модуль для винтов ChMP 3/10

40.6445.301

Moduł na wkręty ChMP 2/10
Module for ChMP screws 2/10
Модуль для винтов ChMP 2/10

40.6445.302

Moduł na wkręty ChMP 1/10
Module for ChMP screws 1/10
Модуль для винтов ChMP 1/10

40.6445.303

Moduł na wkręty ChMP 1/10
Module for ChMP screws 1/10
Модуль для винтов ChMP 1/10

40.6445.001

Moduł na wkręty ChMP 3/10
Module for ChMP screws 3/10
Модуль для винтов ChMP 3/10

40.6445.003

Wkładka z narzędziami ChMP 2/2
Insert with ChMP instruments 2/2
Вкладыш с инструментами ChMP 2/2

40.6447.001

Wkładka na płytki ChMP 1/2
Insert for ChMP plates 1/2
Вкладыш для пластин ChMP 1/2

40.6446.301

Wkładka na płytki ChMP 1/2
Insert for ChMP plates 1/2
Вкладыш для пластин ChMP 1/2

40.6446.001

ZESTAW MINI ChMP
MINI ChMP SET
ИНСТРУМЕНТЫ МИНИ ChMP

PRZYKŁADY KOMPLETACJI
EXAMPLES OF CONFIGURATION
ПРИМЕРЫ КОМПЛЕКТАЦИИ

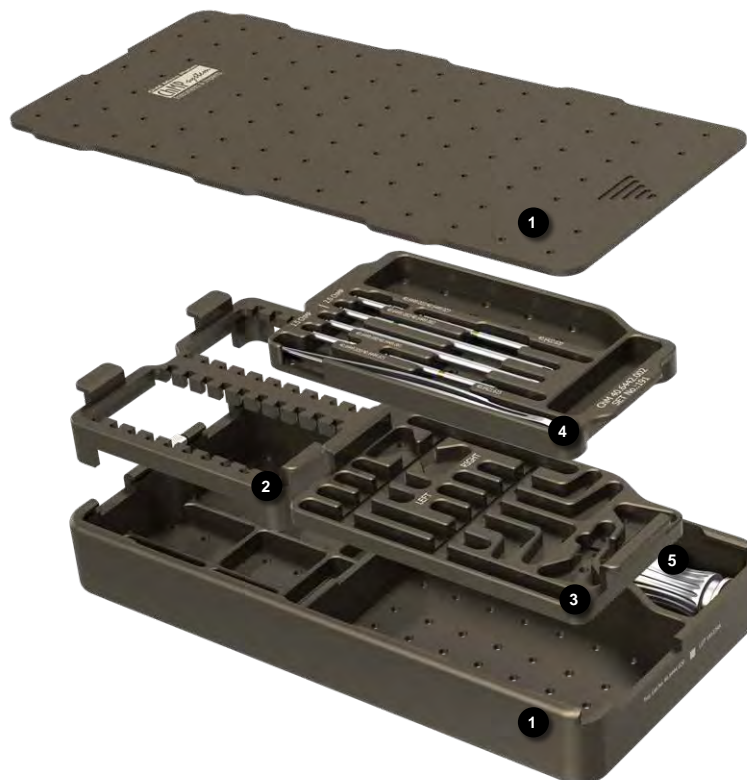

Nazwa/Name/Название		Nr katalogowy Catalogue No. № по кат.
1	Paleta ChMP ChMP palette Поддон ChMP	40.6444.020
2	Moduł na wkręty ChMP Module for ChMP screws Модуль для винтов ChMP	40.6445.005
3	Wkładka na płytki ChMP Insert for ChMP plates Вкладыш для пластин ChMP	40.6446.003
4	Wkładka z narzędziami ChMP Insert with ChMP instruments Вкладыш с инструментами ChMP	40.6442.002
5	Rękojeść z szybkozłączem Quick coupling handle Рукоятка с быстроразъемным соединением	40.6405.100

ZESTAW MINI ChMP
MINI ChMP SET
ИНСТРУМЕНТЫ МИНИ ChMP

Paleta ChMP ChMP palette Поддон ChMP		
	Nazwa/Name/Название	Nr katalogowy Catalogue No. № по кат.
	<p>Paleta ChMP ChMP palette Поддон ChMP</p>	<p>40.6444.020</p>

Narzędzie do palety Instrument for palette Инструмент для поддона		
	Nazwa/Name/Название	Nr katalogowy Catalogue No. № по кат.
	<p>Rękojeść z szybkozłączem Quick coupling handle Ручьятка с быстроразъемным соединением</p>	<p>40.6405.100</p>

ZESTAW MINI ChMP
MINI ChMP SET
ИНСТРУМЕНТЫ МИНИ ChMP

WKLADKI UZUPEŁNIAJĄCE
COMPLEMENTARY INSERTS
ДОПОЛНИТЕЛЬНЫЕ ВКЛАДЫШИ



Wkładka z narzędziami ChMP Insert with ChMP instruments Вкладыш с инструментами ChMP			40.6442.003
	Nazwa/Name/Название	Nr katalogowy Catalogue No. № по кат.	Szt. Pcs Шт.
	Wkładka na narzędzia ChMP Insert for ChMP instruments Вкладыш для инструментов ChMP	40.6443.003	1
	Pinceta anatomiczna delikatna 10,5cm Dissecting forceps delicate 10.5cm Пинцет анатомический деликатный 10,5cm	30.3375.000	1
	Grot X/Screwdriver tip X/Наконечник X	40.6449.021	1
	Grot X/Screwdriver tip X/Наконечник X	40.6449.081	1
	Grot X/Screwdriver tip X/Наконечник X	40.6449.086	1
	Grot X/Screwdriver tip X/Наконечник X	40.6449.026	1
	Wiertło/Drill/Сверло 1,25/15	40.6421.615	1
	Wiertło/Drill/Сверло 0,9/14	40.6429.614	1

Do umieszczenia w palecie ChMP 40.6444.020
To be placed in ChMP palette 40.6444.020
Для размещения на поддоне 40.6444.020





Wkładka z narzędziami ChMP Insert with ChMP instruments Вкладыш с инструментами ChMP			40.6442.002
	Nazwa/Name/Название	Nr katalogowy Catalogue No. № по кат.	Szt. Pcs Шт.
	Wkładka na narzędzia ChMP Insert for ChMP instruments Вкладыш для инструментов ChMP	40.6443.002	1
	Pinceta anatomiczna delikatna 10,5cm Dissecting forceps delicate 10.5cm Пинцет анатомический деликатный 10,5cm	30.3375.000	1
	Grot X/Screwdriver tip X/Наконечник X	40.6449.021	1
	Grot X/Screwdriver tip X/Наконечник X	40.6449.081	1
	Grot X/Screwdriver tip X/Наконечник X	40.6449.083	1
	Grot X/Screwdriver tip X/Наконечник X	40.6449.023	1
	Wiertło/Drill/Сверло 1,25/15	40.6421.615	1
	Wiertło/Drill/Сверло 1,6/20	40.6422.620	1

Do umieszczenia w palecie ChMP 40.6444.020
To be placed in ChMP palette 40.6444.020
Для размещения на поддоне 40.6444.020

ZESTAW MINI ChMP
MINI ChMP SET
ИНСТРУМЕНТЫ МИНИ ChMP

Wkładki na implanty
Inserts for implants
Вкладыши для имплантатов







	Nazwa/Name/Название	Nr katalogowy Catalogue No. № по кат.
	Moduł na wkręty ChMP Module for ChMP screws Модуль для винтов ChMP	40.6445.005
	Wkładka na płytki ChMP Insert for ChMP plates Вкладыш для пластин ChMP	40.6446.003
	Wkładka na płytki ChMP Insert for ChMP plates Вкладыш для пластин ChMP	40.6446.004

Do umieszczenia w paletach ChMP 40.6444.020
To be placed in ChMP palettes 40.6444.020
Для размещения на поддонах 40.6444.020





**NARZĘDZIA OPCJONALNE
OPTIONAL TOOLS
ИНСТРУМЕНТЫ – ОПЦИОНАЛЬНО**

Narzędzia opcjonalne do wkrętów kompresyjnych 3.1030; 3.6658 Optional tools for comperssion screws 3.1030; 3.6658 Инструменты для компрессионных винтов – опционально 3.1030; 3.6658			
 	Wiertło stopniowe 1,2-10 Gradual drill 1.2-10 Сверло фазное 1,2-10	40.8424.010	
	Wiertło stopniowe 1,2-12 Gradual drill 1.2-12 Сверло фазное 1,2-12	40.8424.012	
	Wiertło stopniowe 1,2-14 Gradual drill 1.2-14 Сверло фазное 1,2-14	40.8424.014	
	Wiertło stopniowe 1,2-16 Gradual drill 1.2-16 Сверло фазное 1,2-16	40.8424.016	
	Wiertło stopniowe 1,2-18 Gradual drill 1.2-18 Сверло фазное 1,2-18	40.8424.018	











Narzędzia opcjonalne do wkrętów kompresyjnych 3.1037 Optional tools for comperssion screws 3.1037 Инструменты для компрессионных винтов – опционально 3.1037			
 	Wiertło stopniowe/ Gradual drill/ Сверло фазное 1.25/1.7-14	40.6439.014	
	Wiertło stopniowe/ Gradual drill/ Сверло фазное 1.25/1.7-16	40.6439.016	
	Wiertło stopniowe/ Gradual drill/ Сверло фазное 1.25/1.7-18	40.6439.018	
 	Wiertło stopniowe/ Gradual drill/ Сверло фазное 1.25/1.7-14		40.6439.614
	Wiertło stopniowe/ Gradual drill/ Сверло фазное 1.25/1.7-16		40.6439.616
	Wiertło stopniowe/ Gradual drill/ Сверло фазное 1.25/1.7-18		40.6439.618
 	Wiertło stopniowe/ Gradual drill/ Сверло фазное 1.25/1.7-14		40.6439.714
	Wiertło stopniowe/ Gradual drill/ Сверло фазное 1.25/1.7-16		40.6439.716
	Wiertło stopniowe/ Gradual drill/ Сверло фазное 1.25/1.7-18		40.6439.718

Narzędzia opcjonalne do wkrętów kompresyjnych 3.1027; 3.6662 Optional tools for comperssion screws 3.1027; 3.6662 Инструменты для компрессионных винтов – опционально 3.1027; 3.6662			
 	Wiertło stopniowe/ Gradual drill/ Сверло фазное 1.6/2.0-14	40.6427.014	
	Wiertło stopniowe/ Gradual drill/ Сверло фазное 1.6/2.0-16	40.6427.016	
	Wiertło stopniowe/ Gradual drill/ Сверло фазное 1.6/2.0-18	40.6427.018	
 	Wiertło stopniowe/ Gradual drill/ Сверло фазное 1.6/2.0-14		40.6427.614
	Wiertło stopniowe/ Gradual drill/ Сверло фазное 1.6/2.0-16		40.6427.616
	Wiertło stopniowe/ Gradual drill/ Сверло фазное 1.6/2.0-18		40.6427.618
 	Wiertło stopniowe/ Gradual drill/ Сверло фазное 1.6/2.0-14		40.6427.714
	Wiertło stopniowe/ Gradual drill/ Сверло фазное 1.6/2.0-16		40.6427.716
	Wiertło stopniowe/ Gradual drill/ Сверло фазное 1.6/2.0-18		40.6427.718

INNE NARZĘDZIA
OTHER INSTRUMENTS
ДРУГИЕ ИНСТРУМЕНТЫ

	Nazwa/Name/Название	Nr katalogowy Catalogue No. № по кат.
	Szczypce do cięcia płytek 1,2/1,5 Plate cutting pliers 1.2/1.5 Клещи для резания пластин 1,2/1,5	40.4649.100
	Szczypce do cięcia płytek 12cm Plate cutting pliers 12 cm Клещи для резания пластин 12см	40.6426.000
	Wkręтак kwadratowy 1,2 Square screwdriver 1.2 Отвертка под квадрат 1,2	40.0623.100
	Wkręтак kwadratowy 1,6 Square screwdriver 1.6 Отвертка под квадрат 1,6	40.0626.100
	Szczypce do cięcia płytek 12,5cm Plate cutting pliers 12.5 cm Клещи для резания пластин 12,5см	40.3571.000
	Szczypce do wyginania płytek Plate bending pliers Клещи для выгибания пластин	40.6465.000

**WKREТАK KĄTOWY
ANGULAR SCREWDRIVER
ОТВЕРТКА УГЛОВАЯ**

	Nazwa/Name/Название	Nr katalogowy Catalogue No. № по кат.	Szt. Pcs Шт.
	Wkręтак kątowy Angular screwdriver Отвертка угловая	40.6436.000	1
	Wypychacz Pusher Выталкиватель	40.6438.000	1
	Grot kwadratowy 1,2 Screwdriver square tip 1.2 Наконечник под квадрат 1,2	40.6414.100	2
	 Grot X Screwdriver tip X Наконечник X	40.6449.101	1
	Wiertło, Drill, Сверло 1,25/5	40.6421.505	2
	Wiertło, Drill, Сверло 1,25/7	40.6421.507	2
	Wiertło, Drill, Сверло 1,25/9	40.6421.509	2
	 Grot X Screwdriver tip X Наконечник X	40.6449.103	1
	Wiertło, Drill, Сверло 1,6/6	40.6422.506	2
	Wiertło, Drill, Сверло 1,6/8	40.6422.508	2
	Wiertło, Drill, Сверло 1,6/12	40.6422.512	2
	Paleta na instrumentarium ChMP Palette for ChMP instrument set Поддон д/инструментов ChMP	40.6437.100	1
	Paleta na instrumentarium ChMP Palette for ChMP instrument set Поддон д/инструментов ChMP	40.6437.000	1

ZESTAW PRZEZPOLICZKOWY 2,0
TRANSBUCCAL SET 2.0
НАБОР ДЛЯ КАНЮЛИРОВАНИЯ 2,0

40.6419.300









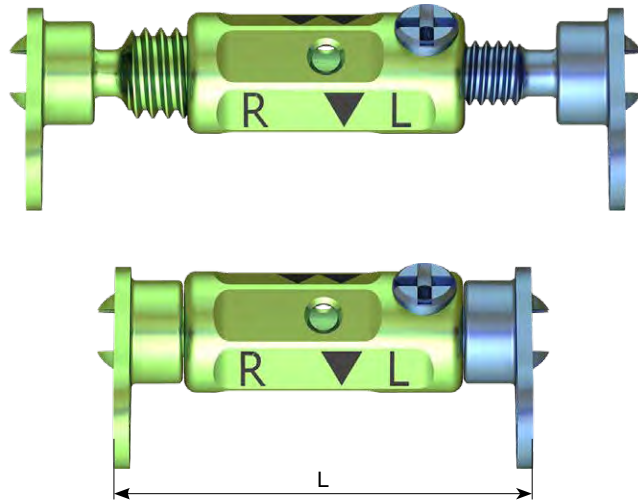



	Nazwa Name Название	Nr katalogowy Catalogue No. № по кат.	Szt. Pcs Шт.
	Prowadnica ochronna Protective guide Направитель-протектор	40.4631.300	1
	Szczeka typ U U type jaw Губки U-образные	40.4632.300	1
	Trokar Trocar Троакар	40.4633.300	2
	Prowadnica wiertła Drill guide Направитель сверла	40.4634.300	1
	Wiertło 1,6/6/100 Drill 1.6/6/100 Сверло 1,6/6/100	40.6423.606	1
	Wiertło 1,6/8/100 Drill 1.6/8/100 Сверло 1,6/8/100	40.6423.608	1
	Wiertło 1,6/10/100 Drill 1.6/10/100 Сверло 1,6/10/100	40.6423.610	1
	Wiertło 1,6/12/100 Drill 1.6/12/100 Сверло 1,6/12/100	40.6423.612	1
	Wiertło 1,6/14/100 Drill 1.6/14/100 Сверло 1,6/14/100	40.6423.614	1
	Wiertło 1,6/16/100 Drill 1.6/16/100 Сверло 1,6/16/100	40.6423.616	1
	Rękojeść Handle Рукоятка	40.8426.000	1
	Statyw na zestaw przezpoliczkowy 2,0 Stand for mini implants 2.0 Подставка д/набора д/канюлирования 2,0	40.6420.300	1
	Kontener na mini implanty 200x145x60mm Szary Container for mini implants 200x145x60mm Grey Контейнер на мини имплантаты 200x145x60мм Серый	12.0756.060	1

MIKROPLYTKA DYSTRAKCYJNA
 DISTRACTION MICROPLATE
 МИНИПЛАСТИНА ДИСТРАКЦИОННАЯ

**	Len	Ti
8	17	3.4499.017
13,5	20	3.4499.020
19	23	3.4499.023
24	26	3.4499.026

** - dystrakcja, distraction, дистракция



Instrumentarium ChMP – 3.4499 ChMP Instrument set – 3.4499 Инструменты для ChMP – 3.4499		40.8409.000	
	Nazwa Название	Nr katalogowy № по каталогу	Szt. Шт.
	Rękojeść z szybkozłączem Quick coupling handle Рукоятка с быстроразъемным соединением	40.6405.100	1
	Grot X Screwdriver tip X Наконечник X	40.6449.023	1
	Grot X Screwdriver tip X Наконечник X	40.6449.083	1
	Wiertło 1,6/8 Drill 1.6/8 Сверло 1,6/8	40.6422.600	1
	Wiertło 1,6/8 Drill 1.6/8 Сверло 1,6/8	40.6422.608	1
	Pinceta anatomiczna Standard, 14,5cm Dissecting forceps STANDARD 14.5cm Пинцет анатомический Стандарт, 14,5см	30.3303.000	1
	Klucz płaski Flat wrench Ключ плоский	40.8402.100	1
	Przymiar 3.4499.017 Trial 3.4499.017 Мера 3.4499.017	43.4499.017	1
	Przymiar 3.4499.020 Trial 3.4499.020 Мера 3.4499.020	43.4499.020	1
	Przymiar 3.4499.023 Trial 3.4499.023 Мера 3.4499.023	43.4499.023	1
	Przymiar 3.4499.026 Trial 3.4499.026 Мера 3.4499.026	43.4499.026	1
	Statyw Stand Подставка	40.8403.000	1

ChM sp. z o.o.

Lewickie 3b

16-061 Juchnowiec Kościelny

Poland

tel. +48 85 86 86 100

fax +48 85 86 86 101

chm@chm.eu

www.chm.eu



CE 0197