

LAPAROSCOPIA BÁSICA



CONFIGURACIÓN CANASTA BÁSICA

PROMED
LAPAROSCOPY

INSTRUMENTAL DE LAPAROSCOPIA

ESPECIFICACIONES TÉCNICAS

- ▶ El ensamble bajo un sistema de conexión mecánicamente seguro desarrollado por TONTARRA.
- ▶ Diseñado para una rotación continua de 360° para una alta precisión de manipulación.
- ▶ Fabricado con plásticos reforzados de alta calidad.
- ▶ El diseño de tres partes permite un mantenimiento y limpieza adecuado con la ventaja de una conexión LUER LOCK integrada para su ensamble.
- ▶ Esterilizable en AUTOCLAVE.
- ▶ Excelente diseño ergonómico.

INDICACIONES

- ▶ Colectectomía laparoscópica
- ▶ Apendicectomía laparoscópica
- ▶ Laparoscopia exploratoria
- ▶ Toma de biopsias

Mango disponible con y sin cremallera

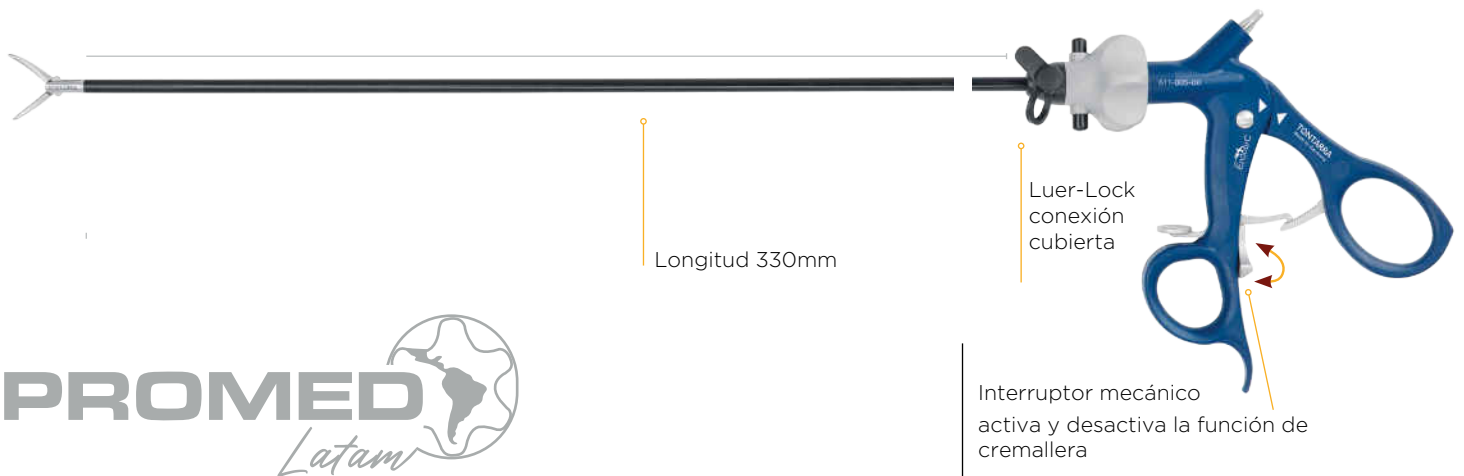

Colocación y extracción del inserto

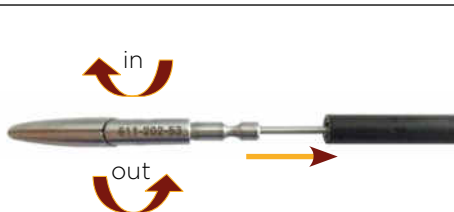

Bloqueo automático en Bayoneta

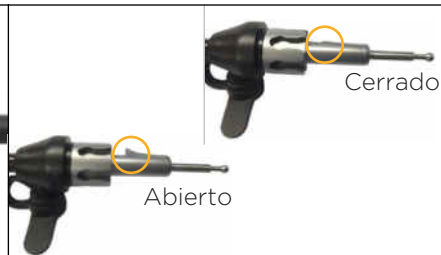

Automatico

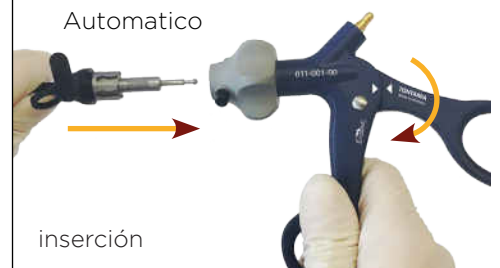



Inserción y remoción del elemento de trabajo



CONFIGURACIÓN CANASTA BÁSICA

PROMED
LAPAROSCOPY



Descripción		Referencia	
TIJERA LAPAROSCÓPICA - METZENBAUM ▶ Tijera estándar curva ▶ Hoja de 14mm	330 mm	41-5900-101311	
MARYLAND ▶ Pinza de agarre y disección ▶ Curva	330 mm	41-5900-101310	



Descripción		Referencia	
GRASPER	330 mm	41-5900-101312	

CONFIGURACIÓN CANASTA BÁSICA

PROMED
LAPAROSCOPY



Descripción	Talla	Referencia
PORTA CLIPS ▶ ETHICON CLIPS	Medium-large	41-5900-101314



Descripción	Referencia	
PINZA EXTRACTORA DE VESÍCULA	41-5900-101313	



Descripción	Referencia	
SUCCIÓN / IRRIGACIÓN ▶ Diámetro 5.0mm	41-5900-101315	





CONFIGURACIÓN CANASTA BÁSICA

PROMED
LAPAROSCOPY

MONOPOLAR de LAPAROSCOPIA

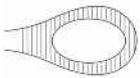

Descripción		Referencia	Referencia	Cable Monopolar	
MONOPOLAR TIPO GANCHO 90°	330 mm	41-5900-101317		41-5900-101318	
MONOPOLAR TIPO ESPATULA	330 mm	41-5900-101316		41-5900-101318	

Descripción		Referencia	
PINZA FOERSTER	20 CM X 8" 	41-5900-101319	





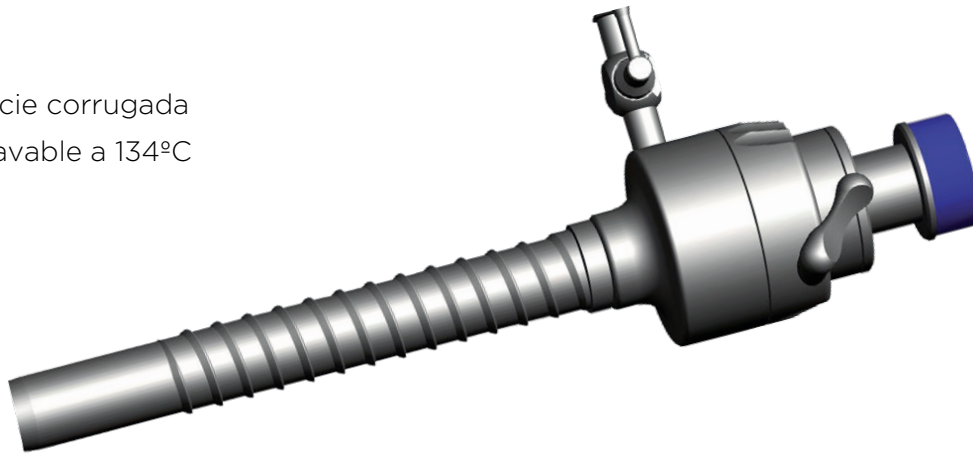

CONFIGURACIÓN CANASTA BÁSICA

PROMED
LAPAROSCOPY

TROCAR METÁLICO REUSABLE

Superficie corrugada
Autoclavable a 134°C



Descripción		Referencia	Referencia	Referencia
CAMISA TROCAR ▶ Punzón dilatador	11 mm	41-590-101320		41-5900-101321 
CAMISA TROCAR ▶ Punzón dilatador	5 mm	41-5900-101324		41-5900-101325 
VÁLVULA	11 mm 5 mm	41-5900-101322 41-5900-101326		
REDUCTORES	11 mm	41-5900-101323		

CONFIGURACIÓN CANASTA BÁSICA

PROMED
LAPAROSCOPY

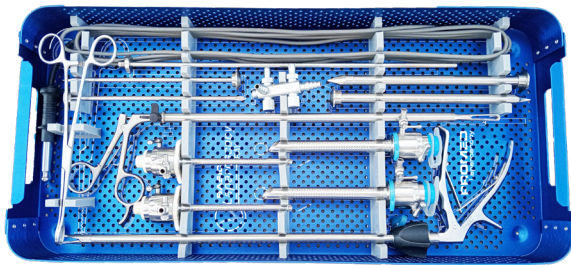
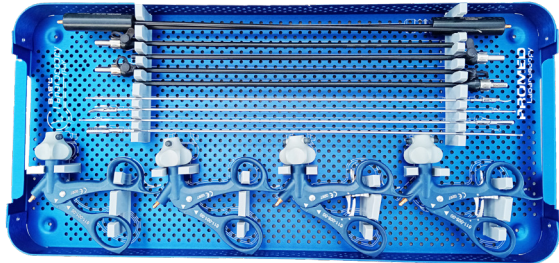

Referencia	Descripción	Cant
41-5900-101310	PINZA MERYLAND	1
41-5900-101311	TIJERA LAPAROSCÓPICA - METZENBAUM	1
41-5900-101312	PINZA GRASPER	2
41-5900-101313	PINZA EXTRACTORA DE VESÍCULA	1
41-5900-101314	PINZA PORTACLIPS	1
41-5900-101315	CANULA DE SUCCIÓN / IRRIGACIÓN	1
41-5900-101316	ELECTRODO MONOPOLAR TIPO ESPATULA	1
41-5900-101317	ELECTRODO MONOPOLAR TIPO GANCHO 90°	1
41-5900-101318	CABLE DE COAGULACIÓN MONOPOLAR	1
41-5900-101319	PINZA FOERSTER	1
41-5900-101320	CAMISA TROCAR REUSABL 11mm	2
41-5900-101321	OBTURADOR PUNZÓN REUSABLE 11mm	2
41-5900-101322	VALVULA 11mm	2
41-5900-101323	REDUCTORES	2
41-5900-101324	CAMISA TROCAR REUSABLE 5,5mm	2
41-5900-101325	OBTURADOR PUNZÓN REUSABLE 5,5mm	2
41-5900-101326	VALVULA 5.5mm	2
41-5900-101300	CAJA DE ESTERILIZACIÓN	1
41-5900-101301	BANDEJA METÁLICA.	2